

USF-105AS

Setup Guide

USF-105AS Packing List:
 USF-105AS (1 unit)
 AC Cord (1 set, AC cord clamp included)
 DVD-ROM (1)
 Air duct unit (1)



1. Installing the AC Cord Clamp

Secure the AC cord with the supplied ladder strap/retaining clip assembly to prevent accidental disconnection from the USF-105AS. Apply before mounting on the rack.

- 1) Wrap the retaining clip around the AC cord. (with the anchor of the ladder strap toward the unit.)
- 2) Insert the anchor into the hole next to the AC IN socket.
- 3) Lightly fasten the clip around the AC cord.
- 4) Plug in the power cord.
- 5) Slide the clip on the ladder strap toward the plug.
- 6) Fasten the clip tightly.
- 7) Gently pull on the AC cord to ensure it is secured.

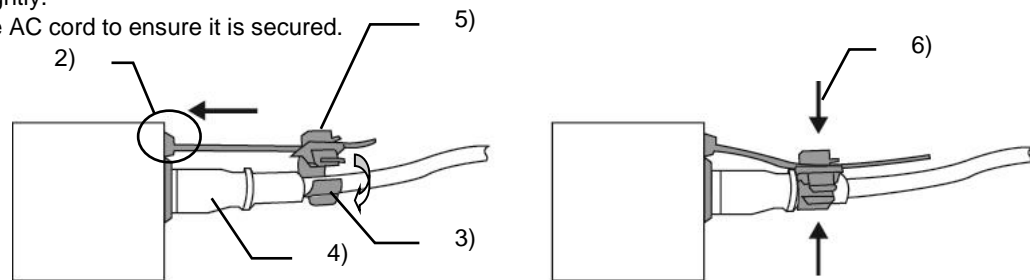

2. Opening the Front Panel

The Front panel may be difficult to open if the USF frame is placed on a desk, and may be damaged the front panel if it is forced to open. Perform the following steps after setting the frame in a rack.

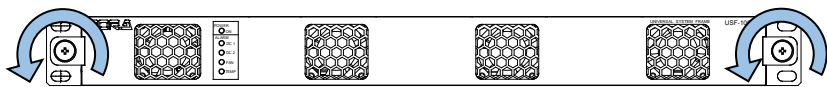

1 Loosen the two thumbscrews of the front panel by turning them counterclockwise.

2 Pull out the front panel grasping the thumbscrews. Cooling fans stop while the front panel is open.

An OPEN alarm sounds intermittently, every 30 seconds, when the front panel is opened. After 5 minutes, the alarm will sound continuously until the front panel is closed. In case the power is on, complete the procedure in a short period of time

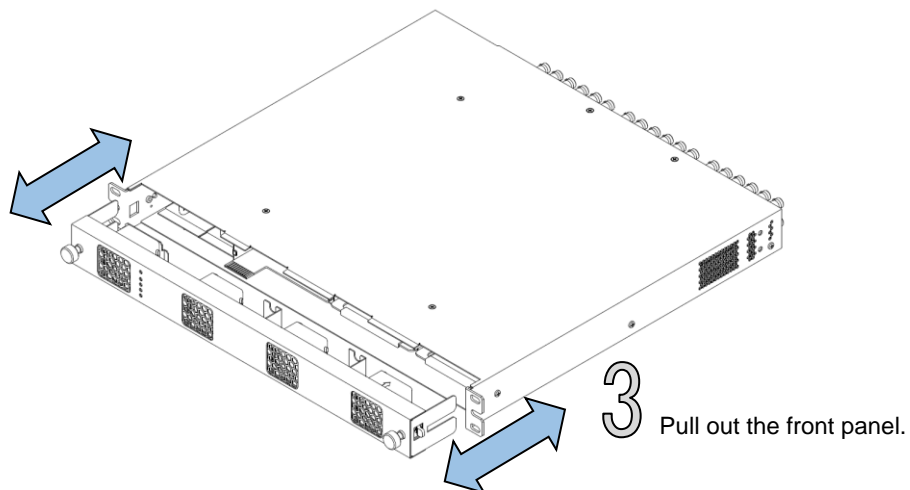

3. Front Interior

The slot configuration as shown below is revealed when the front panel is removed.

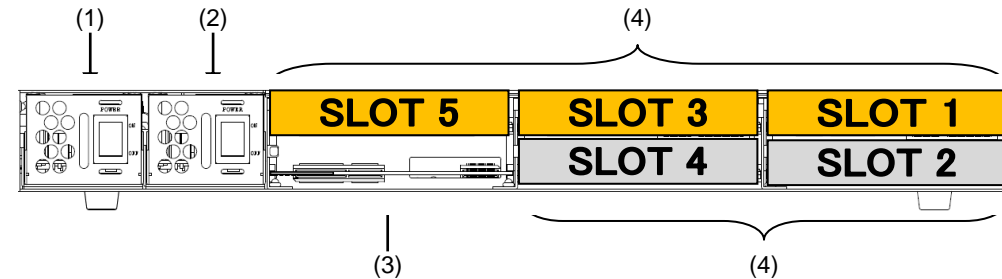

No.	Slot Type	Description
(1)	Power Supply 1 slot	Dedicated power unit is installed in this slot as standard. Power is supplied when the switch is turned on.
(2)	Power Supply 2 slot	Slot for redundant power supply USF-105PS. Redundant operation available when optional USF-105PS is installed. A blank panel will otherwise cover the slot.
(3)	Control module slot	Network module is installed in this slot. Enables you to monitor power supply and fan states via SNMP from back port LAN 1/LAN A and alarm output via GPI. Distributes reference signal to each module.
(4)	USF module slot	Dedicated USF module slots. (Front USF modules) For details on module operation, refer to the respective operation manuals.

4. USF Module Installation

USF Modules can be installed into any free slot if there are no installation slot limitations. If multiple free slots exist, do not install modules side-by-side but leave slots open to prevent overheating and facilitate signal connection from the rear panel. The procedure for installing the USF module in Slot 1 is described below as an example.

Installing a USF Rear Module

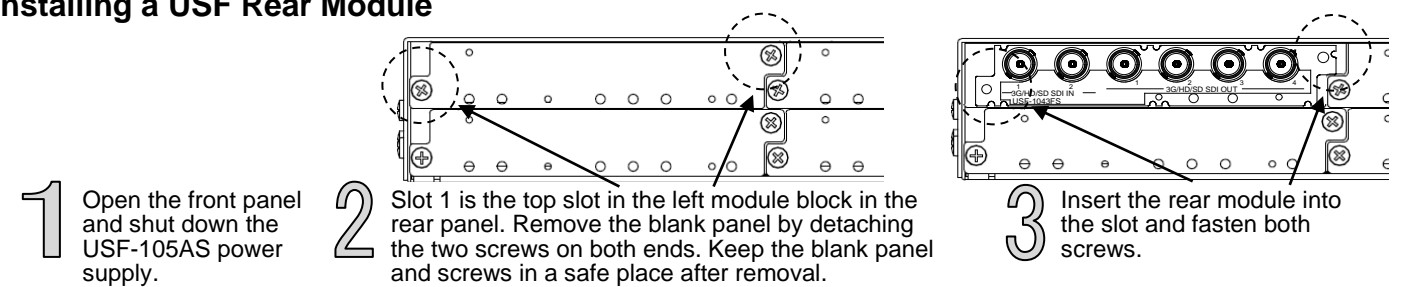

Installing a USF Front Module

Make sure to install the front module after installing the rear module.

- 1) SLOT 1 is the top slot in the right block of the front panel. (Refer to Step 3. "Front Interior.")
- 2) Set the module on the guide rail and carefully insert the module slowly.

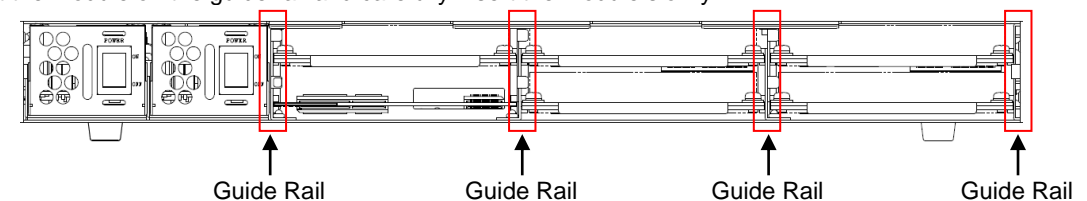

3) Push the front panel handle until the front module clicks into the rear module.

Inserting the module by pressing on other than the handle may damage some parts on the PCB.

Installation Slots for Front and Rear Modules

<Type 1>

Front: 1 slot (All slots)
Rear: 1 slot (All slots)

Available modules:	
105DADA	402AADC
108ADA	1013MUX
1040VEA	1013DEMUX
1053DDA	1043FS
105DDA-12G	105FS-12G*
204ADAC	1043VM
105DDA-12GA	

<Type 2>

Front: 1 slot (Slot 2 and slot 4 only)
Rear: 2 slot (Upper and lower)

Available modules:	
1100VEA	1044UDC



<Type 3>

Front: 1 slot (Slot 1 and slot 3 only)
Rear: 2 slot (Upper and lower)



Available modules:	
101MDX4-12G*	101MDX8-12G*
106UDC-12G*	106TICO-12G*
106DC-12G*	111DDA-12G

Modules that can be remotely controlled from a PC require installation of both Processor Control GUI Launcher and GUI Control Software.

Modules:	
106UDC-12G	106DC-12G
101MDX4-12G	101MDX8-12G
105FS-12G	106TICO-12G
See the Processor Control GUI Launcher Operation Manual for details.	

When installing 12G-SDI supported modules (marked with *), install the supplied air duct unit into Slot 5.

NOTE

- USF Modules come as front and rear sets. Be sure to install set modules into the same (front and rear) slot locations.
- Make sure to install the rear module first, then install the front module.
- Install blank panels over free slots to prevent foreign material from entering and overheating the chassis.
- Some modules cannot be installed into Slot 5.

IMPORTANT

- Beware of the occurrence of electrical breakdown in USF Modules.
- Wear an antistatic wrist strap or equivalent to equalize the electrical potential of the USF-105AS unit and the worker's body. Do not touch the PCB wiring or parts legs directly with your fingers while working.
- Each USF Module can be installed and uninstalled while the power is on in case of emergency. Shut down the power for non-emergency work.
- When front module is being installed / uninstalled while the power is on, the front panel is in open state. The fan will stop during the procedure, so it is essential to complete the installation within a short period and to close the front panel immediately.
- Be sure to shut down the power to install and uninstall a control module.

5. Connecting USF-105AS to a PC

When USF-105AS is network connected via network to a PC, operation can be monitored on Web/SNMP manager using a web browser, and GPIO alarm setting can be entered. There are two ways to connect USF-105AS to a PC; using LAN A or LAN 1 port. Select a suitable port in accordance with system configuration.

LAN A port connection

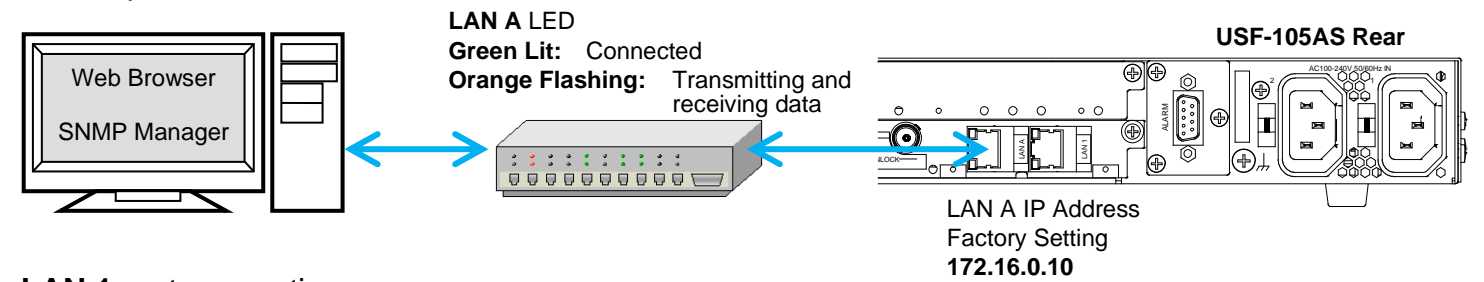

LAN 1 port connection

Connect to the rear panel LAN1 port.

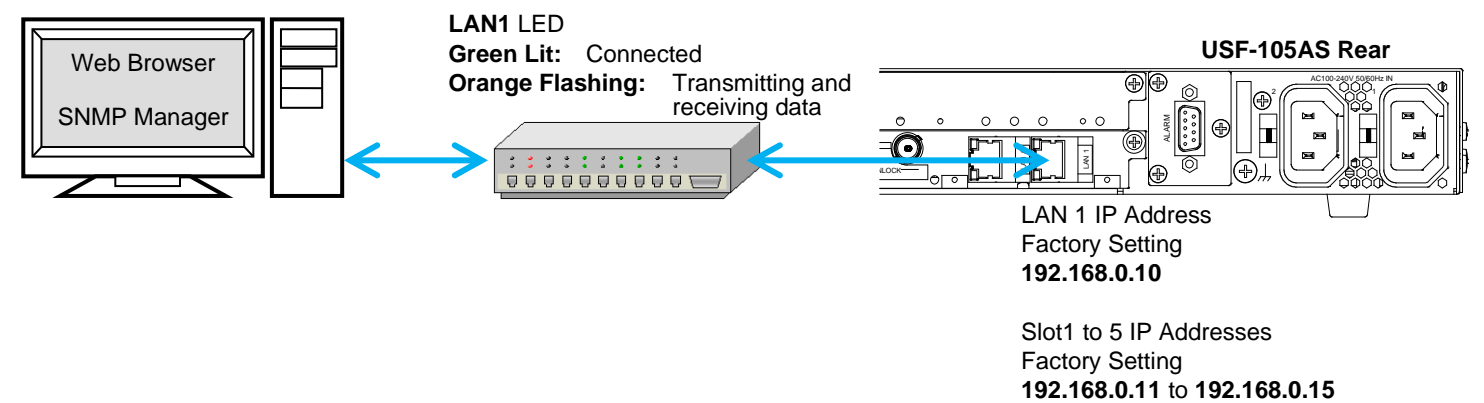

6. Network Default Setting

Open the web browser of the PC and input address.

Connecting to LAN A: <http://172.16.0.10/> (Factory Setting)
Connecting to LAN 1: <http://192.168.0.10/> (Factory Setting)

A status page as shown opens on the web browser when connection is established.

IP Address Change

- 1) Click the **Network** tab.
- 2) Changing LAN A IP address:
Input new IP Address in the white box under **WAN(LAN A) Settings**.

Changing LAN1 IP address:
Input new IP Address in the white box under **LAN (LAN1) Settings**
- 3) A confirmation message window opens when you click **Apply**.
Click **OK** in the confirmation window.
- 4) Click **Utility** tab, then click **Restart**.
Click **OK** when the restart confirmation window opens.
USF-105AS restarts. The new setting is reflected after the restart.

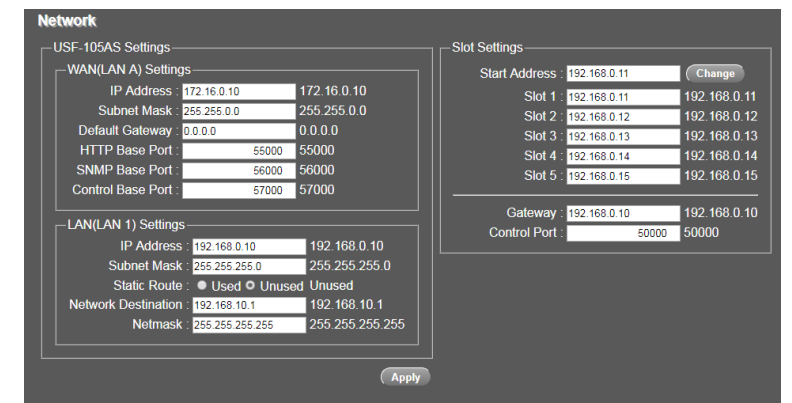

IP addresses are assigned to respective USF-105AS modules installed. Refer to USF-105AS operation manual Sec.10 "USF-105AS Web GUI" for details on setting IP addresses.