

# 10 GbE IP CONVERTER (IP GATEWAY) USF-10IP SERIES

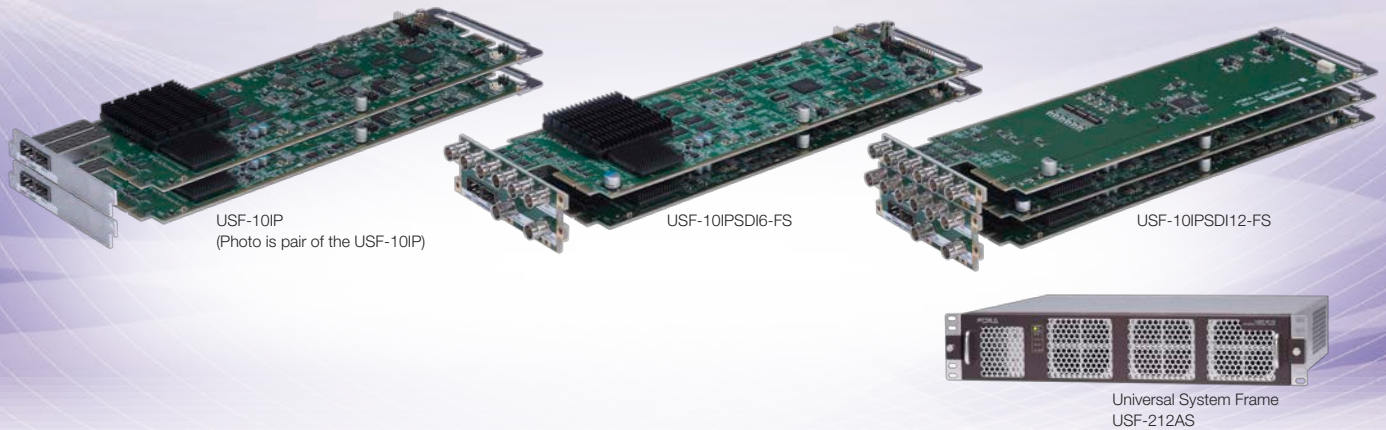

Video-over-IP module for Universal System Frame USF-212AS. USF-10IP Series converts video and audio signal between IP formats (SMPTE ST 2022-6/ST 2110) and between IP and SDI. Compatible with 4K (2SI/SQD) and multi-format input and output. Dual 10 GbE (SFP+) module can be installed supporting hitless operation.

## Baseband and IP Hybrid System

For an IP system, the SMPTE ST 2022-6 standard is mainly used in transmission. In a production system, SMPTE ST 2110 is the most commonly used standard. In the future, baseband and IP, as well as ST 2022-6 and ST 2110 may be mixed for production applications. With the USF-10IP series, IP and baseband interconversion, ST 2022-6 and ST 2110 interconversion is also provided.

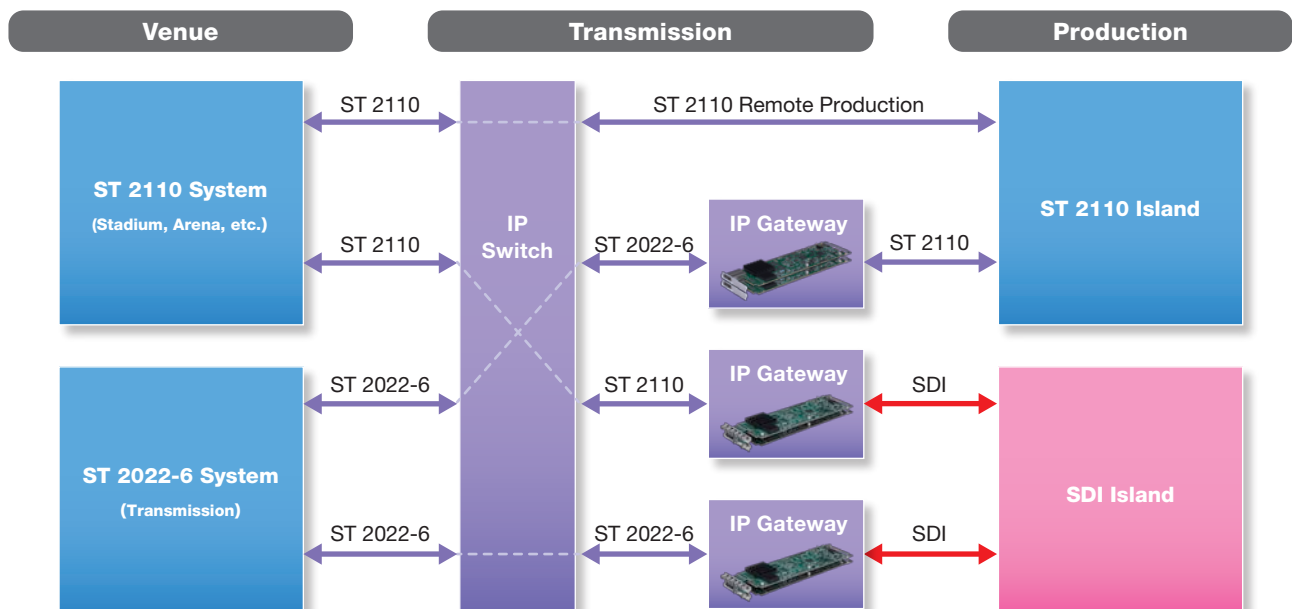

# 10 GbE IP CONVERTER (IP GATEWAY)

## Available Modules

### USF-10IP

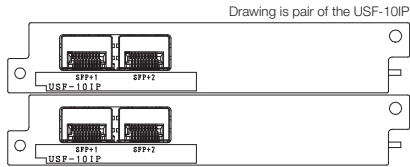

- Dual 10 GbE (SFP+) port supports hitless operation for redundancy
- Converts to other capsulation modes (Using pair of the USF-10IP modules)
- Encapsulation modes:  
SMPTTE ST2022-6/7, SMPTTE 2110

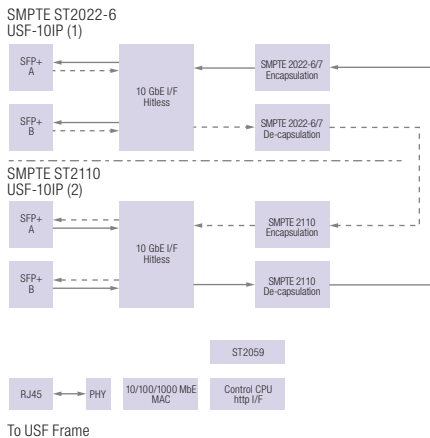

### USF-10IPSDI6-FS

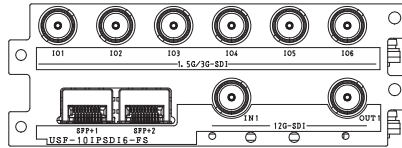

- Dual 10 GbE (SFP+) port supports hitless operation for redundancy
- 1-input/1-output 12G-SDI
- 6-input/output 3G/1.5G-SDI
- 2SI/SQD conversion, Level A/B compatible
- SMPTTE 2022-6 (uncompressed):  
Simultaneous conversion of up to 6 inputs and 6 outputs (6 streams)
- Encapsulation modes:  
SMPTTE ST2022-6/7, SMPTTE 2110
- TICO codec support (SMPTTE ST 2022-6)

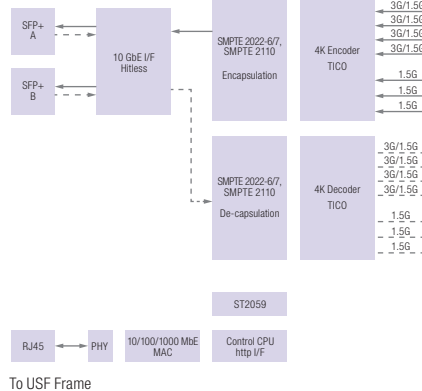

### USF-10IPSDI12-FS

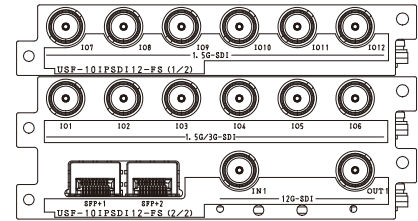

- Dual 10 GbE (SFP+) port supports hitless operation for redundancy
- 1-input/1-output 12G-SDI
- 12-input/output 3G/1.5G-SDI
- 2SI/SQD conversion, Level A/B compatible
- SMPTTE 2022-6 (uncompressed):  
Simultaneous conversion of up to 6 inputs and 6 outputs (12 streams)
- Encapsulation modes:  
SMPTTE ST2022-6/7, SMPTTE 2110
- TICO codec support (SMPTTE ST 2022-6)

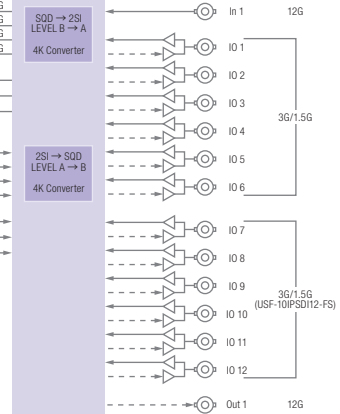

## Specifications

	USF-10IP	USF-10IPSDI6-FS	USF-10IPSDI12-FS
Video input	SFP+ 1 channel (2 ports for redundancy)	1 channel (2 ports for redundancy)	1 channel (2 ports for redundancy)
	SDI	12G-SDI: 12 Gbps, BNC x 1 3G/1.5G-SDI: 3/1.5 Gbps, BNC x 6 (input/output switching) Signal format*1: 2SI or SQD (Level A/B*)	12G-SDI: 12 Gbps, BNC x 1 3G/1.5G-SDI: 3/1.5 Gbps, BNC x 12 (input/output switching) Signal format*1: 2SI or SQD (Level A/B*)
Video output	SFP+ 1 channel (2 ports for redundancy)	1 channel (2 ports for redundancy)	1 channel (2 ports for redundancy)
	SDI	12G-SDI: 12 Gbps, BNC x 1 3G/1.5G-SDI: 3/1.5 Gbps, BNC x 6 (input/output switching) Signal format*1: 2SI or SQD (Level A/B*)	12G-SDI: 12 Gbps, BNC x 1 3G/1.5G-SDI: 3/1.5 Gbps, BNC x 12 (input/output switching) Signal format*1: 2SI or SQD (Level A/B*)
IP format*2	SMPTTE 2022-6/7, SMPTTE 2110		
Max. number of modules mountable on USF-212AS	10 (5 pairs)*2	5	3

\*1 When using 3G-SDI \*2 Required dedicated frame. please contact to a FOR-A sales person.



Head Office: 3-8-1 Ebisu, Shibuya-ku, Tokyo 150-0013, Japan

ISO 9001 and 14001 certified (Sakura R&D)

[www.for-a.com](http://www.for-a.com)

**FOR-A Corporation of America Corporate Office/ Service Center:**

11155 Knott Ave., Suite G, H & I, Cypress, CA 90630, U.S.A.

Tel: +1 714-894-3311

**FOR-A Corporation of America Northeast Office:**

1360 Clifton Ave., Clifton, NJ 07012, U.S.A.

Tel: +1 973-220-847

**FOR-A Corporation of America Support Center:**

2400 N.E. Waldo Road, Gainesville, FL 32609, U.S.A.

Tel: +1 352-371-1505

**FOR-A Latin America and the Caribbean Miami Office:**

Via Volturmo, 37, 20861 Brughiero MB, Italy

Tel: +1 657-600-5759

**FOR-A Latin America and the Caribbean Sao Paulo Office:**

Via Volturmo, 37, 20861 Brughiero MB, Italy

Tel: +55 11-99913-3751

**FOR-A Europe S.r.l.:**

Via Volturmo, 37, 20861 Brughiero MB, Italy

Tel: +39 039-916-4811

**FOR-A UK Limited:**

Trident Court, 1 Oakcroft Road, Chessington, KT9 1BD, UK

Tel: +44 (0)20-3044-2935

**FOR-A Italia S.r.l.:**

Via Volturmo, 37, 20861, Brughiero MB, Italy

Tel: +39 039-881-086/103

**FOR-A Corporation of Korea:**

1007, 57-5, Yangsan-ro, Yeongdeungpo-gu, Seoul 150-103, Korea

Tel: +82 (0)2-2637-0761

**FOR-A China Limited:**

1618 Huateng Building, No. 302, 3 District, Jinsong, Chaoyang, Beijing 100021, China

Tel: +86 (0)10-8721-6023

**FOR-A Middle East-Africa Office:**

Dubai Media City, Aurora Tower, Office 1407, P.O. Box 502688, Dubai, UAE

Tel: +971 (0)4-551-5830

**FOR-A India Private Limited:**

2nd Floor, Valecha Chambers, Link Road, Andheri (W), Mumbai 400053, India

Tel: +91 22-2673-3623

**FOR-A South East Asia Office:**

Studio 09, Rm. A1, 3/F., Phase 1, Hang Fung Ind. Bldg., 2G Hok Yuen St., Hung Hom, Hong Kong

Tel: +852 2110-1352