

OPERATION MANUAL

UFM-30FRC

HD/SD/Analog Composite Frame Rate
Converter

1st Edition - Rev.1

Edition Revision History

Edit.	Rev.	Date	Description	Section/Page
0	-	2012/01/31	Preliminary	
1	-	2012/03/15	Added section 7-1. "SD to HD (Without Genlock)."	7-1
1	1	2012/03/30		2-1, 4-1-2, 4-2, 5, 5-1-1, 5-1-2, 5-1-5, 5-1-14, 9-1



Precautions

Important Safety Warnings

[Power]

 Stop	<p>Do not place or drop heavy or sharp-edged objects on power cord. A damaged cord can cause fire or electrical shock hazards. Regularly check power cord for excessive wear or damage to avoid possible fire / electrical hazards.</p>
---	--

[Circuitry Access]

 Stop	<p>Do not touch any parts / circuitry with a high heat factor. Capacitors can retain enough electric charge to cause mild to serious shock, even after power is disconnected. Capacitors associated with the power supply are especially hazardous. Avoid contact with any capacitors.</p>
 Hazard	<p>Unit should not be operated or stored with cover, panels, and / or casing removed. Operating unit with circuitry exposed could result in electric shock / fire hazards or unit malfunction.</p>

[Potential Hazards]

 Caution	<p>If abnormal smells or noises are noticed coming from the unit, turn power off immediately and disconnect power cord to avoid potentially hazardous conditions. If problems similar to above occur, contact authorized service representative before attempting to again operate unit.</p>
---	---

[Consumables]

 Caution	<p>The consumables used in unit must be replaced periodically. For further details on which parts are consumables and when they should be replaced, refer to the specifications at the end of the Operation Manual. Since the service life of the consumables varies greatly depending on the environment in which they are used, they should be replaced at an early date. For details on replacing the consumables, contact your dealer.</p>
--	--

Upon Receipt

Unpacking

UFM-30FRC modules and their accessories are fully inspected and adjusted prior to shipment. Operation can be performed immediately upon completing all required connections and operational settings.

Check your received items against the packing lists below.

ITEM	QTY	REMARKS
UFM-30FRC	1 set	Front module: 1 Rear module: 1
Operation Manual	1	(This manual)

Check

Check to ensure no damage has occurred during shipment. If damage has occurred, or items are missing, inform your supplier immediately.

Table of Contents

1. Prior to Starting	1
1-1. Welcome	1
2. Panel Descriptions	2
2-1. Front Panel	2
2-2. Rear Panel	2
3. Connection and Setup	3
3-1. Connection	3
3-2. Note on Composite Input	4
3-3. Composite Monitor Setup	4
4. Operation	5
4-1. Power On	5
4-1-1. UF-106A or UF-106B	5
4-1-2. UF-112	5
4-2. Menu Operation	6
5. Menu List	7
5-1. Menu Description	9
5-1-1. Video Process AMP	9
5-1-2. Aspect Ratio	9
5-1-2-1. Aspect Ratio Setting Displays	10
5-1-3. Composite	13
5-1-4. Motion Compensation	13
5-1-5. Enhancer	14
5-1-6. Film	15
5-1-7. Audio Delay	15
5-1-8. Input Select	15
5-1-9. System Phase	16
5-1-10. Output	16
5-1-11. Reference	17
5-1-12. Closed Caption	17
5-1-13. Test Signal	17
5-1-14. System Status (Display Only)	18
5-1-15. SDI Audio Status (Display Only)	18
5-1-16. Module Information (Display Only)	18
6. Processing Delay	19
7. Conversion Examples	20
7-1. SD to HD (Without Genlock)	20
7-2. SD to HD (with Genlock)	21
7-3. HD to HD (Frame Rate Conversion)	22
8. Troubleshooting	23
9. Specifications and Dimensions	24
9-1. Specifications	24
9-2. External Dimensions	25

1. Prior to Starting

1-1. Welcome

Congratulations! By purchasing a UFM-30FRC HD/SD/Analog Composite Frame Rate Converter you have entered the world of FOR-A and its many innovative products. Thank you for your patronage and we hope you will turn to FOR-A products again and again to satisfy your video and audio needs.

FOR-A provides a wide range of products, from basic support units to complex system controllers, which have been increasingly joined by products for computer video based systems. Whatever your needs, talk to your FOR-A representative. We will do our best to be of continuing service to you.

This modular-type UFM-30FRC Frame Rate Converter can be installed into the UFM frame. The UFM-30FRC is provided with a motion compensation processing mode and linear converter mode to perform optimal conversions in accordance with the target videos. It is equipped with up-, down-, and cross-converters as standard features. The UFM-30FRC can perform wide-ranging format conversion.

Available Combinations of Input and Output Formats

Input signal format		Output signal format	
HD-SDI	1080/59.94i	HD-SDI	1080/59.94i
	1080/50i		1080/50i
	1080/23.98PsF		1080/23.98PsF
	720/59.94p		720/59.94p
	720/50p		720/50p
SD-SDI	525/60	SD-SDI	525/60
	625/50		625/50
Composite	NTSC		
	PAL		

- HD/SD-SDI frame rate converter. Analog composite input also available.
- HD/SD-SDI: 1-input/2-output. Composite: 1-input
- Embedded audio pass-through: 16 ch (Group1, 2, 3 and 4)
- Menu display on Analog Composite Out using OSD
- Built-in frame synchronizer (Black Burst and Tri-level Sync) *1
- Proc Amp
- Closed caption pass-through
- Control and monitor with a standard web browser via Ethernet using the WEB control function of UFM-30CTL *2

*1 With BB input, UFM-30FRC gen-locks signals horizontally (H lock), but does not correct subcarrier phase shifts.

*2 Support planned from the 2nd Version.

2. Panel Descriptions

2-1. Front Panel

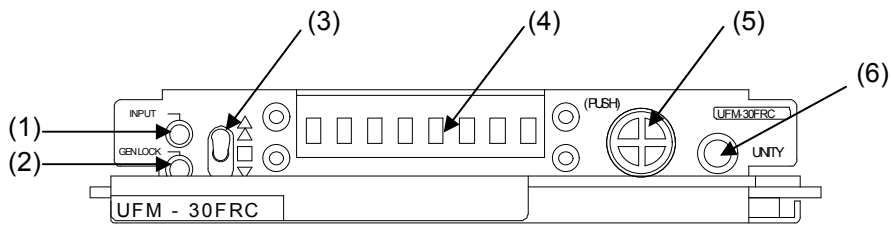

No.	Name	Description	
(1)	INPUT LED	Lit	Video signal normally present.
		Unlit	No video signal present.
(2)	GENLOCK LED	Lit	Signals properly phase-locked and synchronized.
		Unlit	No genlock signal present or 43-01 Reference Source is set to Free .
(3)	Up and down switch	Allows you to navigate between menus.	
(4)	Menu display	Displays parameters and parameter values.	
(5)	Menu control	Allows you to navigate between menus and adjust settings.	
(6)	UNITY/display switching switch	Allows you to change between default and current settings. Allows you to change between detailed and summarized menu number and parameter displays.	

2-2. Rear Panel

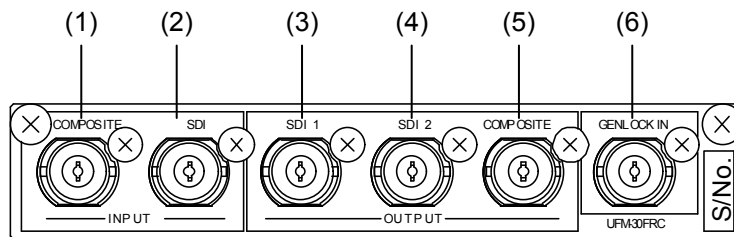

No.	Name		Description
(1)	INPUT	COMPOSITE	Used to input a Composite signal.
(2)	INPUT	SDI	Used to input an HD/SD-SDI signal.
(3)	OUTPUT	SDI 1	Used to output an HD/SD-SDI signal.
(4)	OUTPUT	SDI 2	
(5)	OUTPUT	COMPOSITE	Used to monitor composite video output. See section 3-3. "Composite Monitor Setup" for details.
(6)	GENLOCK IN		Used to input a reference signal.

3. Connection and Setup

3-1. Connection

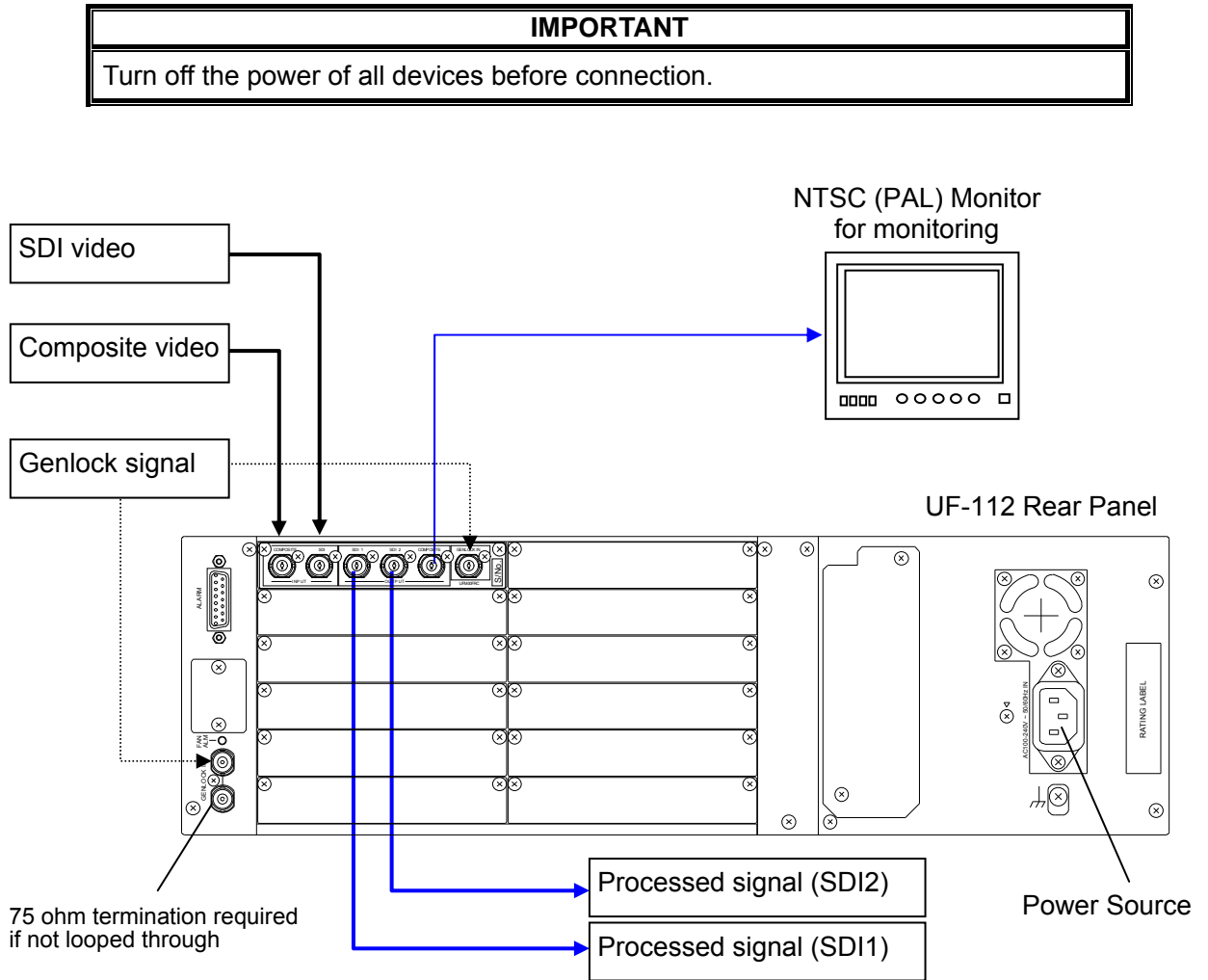

IMPORTANT

Although two video inputs are provided, only one input can be processed through the UFM-30FRC at a time.

The processed video is simultaneously sent to three ports; SDI1, SDI2 and COMPOSITE.

With BB input, the UFM-30FRC gen-locks signals horizontally (H lock), but does not correct subcarrier phase shifts.

3-2. Note on Composite Input

When the NTSC composite signal is input, the setup level should be set manually in the menu. The factory default setting is Off (7.5IRE). See section 4-2. "Menu Operation" for details on changing menu settings.

NTSC setup level	Parameter	Setting
0IRE (Japan)	02-02 CVBS IN pedestaling	Off
7.5IRE (e.g., US)	I02-02 CVBS IN pedestaling	On (default setting)

3-3. Composite Monitor Setup

An NTSC or PAL output monitor is required.

Monitor	Output Signal
NTSC monitor	59.94Hz
PAL monitor	50Hz

Connect the monitor to the **COMPOSITE** connector on the UFM-30FRC rear panel. If NTSC monitor is used, set the setup level. The default setting in the UFM-30FRC is **7.5 IRE**.

◆ **For an NTSC Monitor with 0 IRE Setup (Japan)**

Change the **CVBS Output standard** setting under the **VIDEO** menu from **PAL/NTSC** to **PAL/NTSC-J**.

See section 4-2. "Menu Operation" for details on changing menu settings.

◆ **Monitoring Output Image**

The output image is also displayed on the Composite monitor when SD is selected for signal output. However, in some cases, the signal is unable to be displayed properly because the **COMPOSITE OUT** images are not phase-adjusted by the reference signal.

4. Operation

4-1. Power On

4-1-1. UF-106A or UF-106B

Example: UF-106B

- 1) Loosen and pull the screw knobs on both sides to open the front panel of the UF-106B.

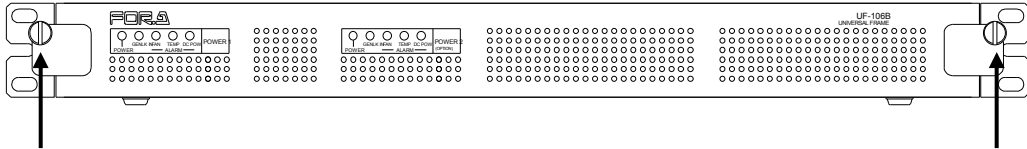

- 2) Make sure all devices are properly connected and turn on the power of the UFM frame.

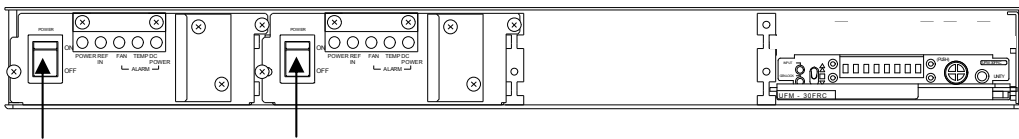

4-1-2. UF-112

- 1) Loosen and pull the screw knobs on both sides to open the front panel of the UF-112.

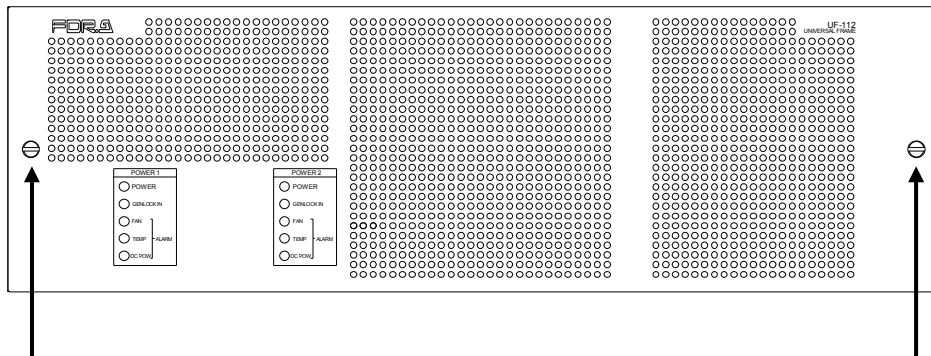

- 2) Make sure all devices are properly connected and turn on the power of the UFM frame. After startup, "UFM-30FRC" appears on the front panel. The unit will take about 30 seconds to power on. If video and genlock signals are input, the **INPUT** and **GENLOCK** indicators light up green.

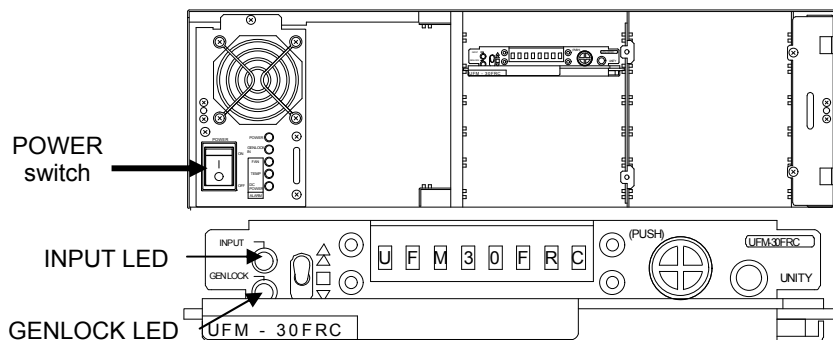

4-2. Menu Operation

- 1) Turn the menu control and display the desired menu. Move the switch up and down to navigate between menus (menus shaded in the menu list in section 5). Pressing the **UNITY** switch while a menu is selected scrolls the screen to the side and displays detailed information.

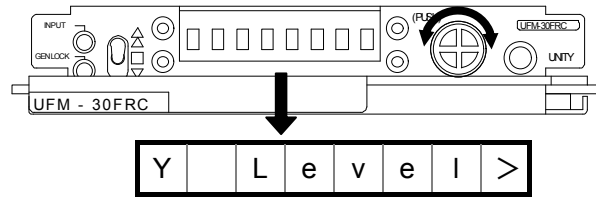

- 2) Press the menu control. The parameter value will be displayed.

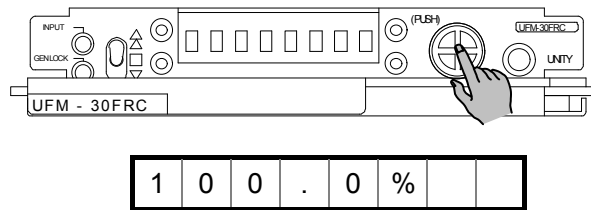

- 3) Turn and press the menu control to select the value and apply the setting. Pressing the **UNITY** switch resets the setting to default. (Pressing the **UNITY** switch one more time undoes the last change.)

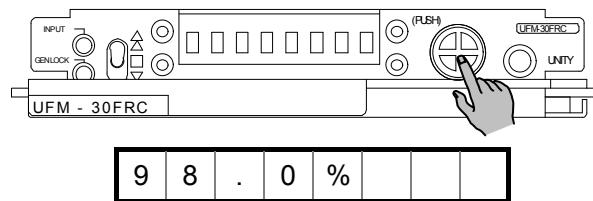

- 4) Move the up and down switch to the down position to return to the menu selection.

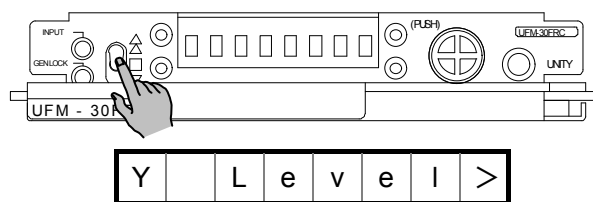

Repeat steps 1) – 4) to set all necessary settings.

5. Menu List

Menu Category	Description
VIDEO	Allows you to set how to process videos.
AUDIO	Allows you to select input and output audio feeds, and set audio settings.
SYSTEM	Allows you to select input and output video signals, and set reference signal and ancillary data settings.
UTILITY	Allows you to set the test signal.
STATUS	Displays status of video and audio feeds, and the module.

Menu Category	Menu				Refer To
	No.	Parameter	Abbreviated Display	Default	
VIDEO	00	Video process AMP	PROCAMP		5-1-1
	00-01	Setup level	SET LVL >	0.0%	
	00-02	Luma level	Y Level >	100.0%	
	00-03	Chroma level	C Level >	100.0%	
	01	ARC Process	ARC		5-1-2
	01-01	SD Input format	SD IN >	Normal	
	01-02	SD Output format	SD OUT >	Normal	
	01-03	Upconvert scaling	Upscale >	Fit to height	
	02	CVBS Input/Output	CVBS I/O		5-1-3
	02-01	CVBS Output standard	CVBSOut >	PAL/NTSC	
	02-02	CVBS IN pedestaling	CVBSPed >	On	
	03	Motion Compensation	MOT COMP		5-1-4
	03-01	Motion process	MC PROC >	On	
	03-02	Motion sense	M SENSE >	On	
	03-03	Caption bias	MC CAP >	3	
	04	Enhancer	Enhancer		5-1-5
	04-01	H Enhancer detail	H ENH D >	Normal	
	04-02	H Enhancer sharpness	H ENH S >	Normal	
	04-03	V Enhancer frequency	V ENH F >	Medium	
	04-04	V Enhancer level	V ENH >	Normal	
05	Film	Film		5-1-6	
05-01	Film cadence insert	Film3:2 >	Off		
AUDIO	23	SDI Audio delay	SDI DLY		5-1-7
	23-01	Audio delay unit	SDI D U >	0	
SYSTEM	40	System setting	System		5-1-8
	40-01	Input select	IN SEL >	HD/SD-SDI	
	40-02	Sync mode	SYNCMOD >	Off	
	41	System phase	SYSPhase		5-1-9
	41-01	System phase H	SYPH H >	0	
	41-02	System phase V	SYPH V >	0	
	42	Output	Output		5-1-10
	42-01	Output standard	OUT STD >	525/60	
	43	Reference	REF		5-1-11
	43-01	Reference source	REF SRC >	Free	
44	Closed caption	CLS CAP		5-1-12	
44-01	Closed caption 608	CC 608 >	Off		
UTILITY	60	Test signal	Test SIG		5-1-13
	60-01	Video test signal	Video TS >	Off	

(Continued on next page)

Menu Category	Menu			Refer To
	No.	Parameter	Abbreviated Display	
STATUS	80	System Status	SYS STS	5-1-14
	80-01	Input signal	IN SIG >	
	80-02	Output signal	OUT SIG >	
	80-03	Reference standard	REF STD >	
	81	SDI Audio status	SDIA STS	5-1-15
	81-01	SDI Input status ch1/2	SDIS1/2 >	
	81-02	SDI Input status ch3/4	SDIS3/4 >	
	81-03	SDI Input status ch5/6	SDIS5/6 >	
	81-04	SDI Input status ch7/8	SDIS7/8 >	
	81-05	SDI Input status ch9/10	SDIS9/10 >	
	81-06	SDI Input status ch11/12	SDIS11/12 >	
	81-07	SDI Input status ch13/14	SDIS13/14 >	
	81-08	SDI Input status ch15/16	SDIS15/16 >	
	83	Module information	MDL INFO	5-1-16
	83-01	Slot number	SLOT NO >	
	83-02	CPU Version information	CPU >	
83-03	FPGA Version information	FPGA >		
83-04	Fan alarm	FAN >		
83-05	Temperature alarm	TEMP >		

5-1. Menu Description

5-1-1. Video Process AMP

Menu		Default	Setting Range (Units)	Description
No.	Parameter			
00	Video process AMP			
00-01	Setup level	0.0%	-14.0 to 14.0% (0.1%)	Allows you to adjust the black level.
00-02	Luma level	100.0%	70.0 to 130.0% (1.0%)	Allows you to adjust the video level.
00-03	Chroma level	100.0%	70.0 to 130.0% (1.0%)	Allows you to adjust the chroma level.

5-1-2. Aspect Ratio

The aspect ratio settings are set under the following three parameters. "ARC" in the table below stands for Aspect Ratio Conversion.

◆ **SD Input format**

Allows you to specify the input video aspect ratio.

◆ **SDI Output format**

Allows you to specify the output video aspect ratio.

◆ **Upconvert scaling**

Allows you to select the automatic aspect ratio setting mode.

Menu		Default	Setting Range	Description
No.	Parameter			
01	ARC Process			
01-01	SD Input format	Normal	Normal	Specifies the aspect ratio of input to 4:3.
			16:9 Anamorphic	Specifies the aspect ratio of input to 16:9 anamorphic (squeezing 16:9 to 4:3).
			16:9 Letterbox	Specifies the aspect ratio of input to 16:9.
			13:9 Letterbox	Specifies the aspect ratio of input to 13:9.
			14:9 Letterbox	Specifies the aspect ratio of input to 14:9.
01-02	SD Output format	Normal	Normal	Specifies the aspect ratio of output to 4:3. Both sides of the video are cut off.
			16:9 Anamorphic	Specifies the aspect ratio of output to 4:3.
			16:9 Letterbox	Specifies the aspect ratio of output to 16:9.
			13:9 Letterbox	Specifies the aspect ratio of output to 13:9.
			14:9 Letterbox	Specifies the aspect ratio of output to 14:9.
01-03	Upconvert scaling	Fit to height	Fit to height	Scales the image based on its height when SD signals are input.
			Fit to width	Scales the image based on its width when SD signals are input.

5-1-2-1. Aspect Ratio Setting Displays

Up-Conversion (SD to HD)

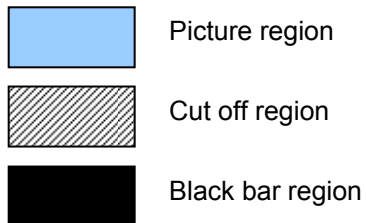
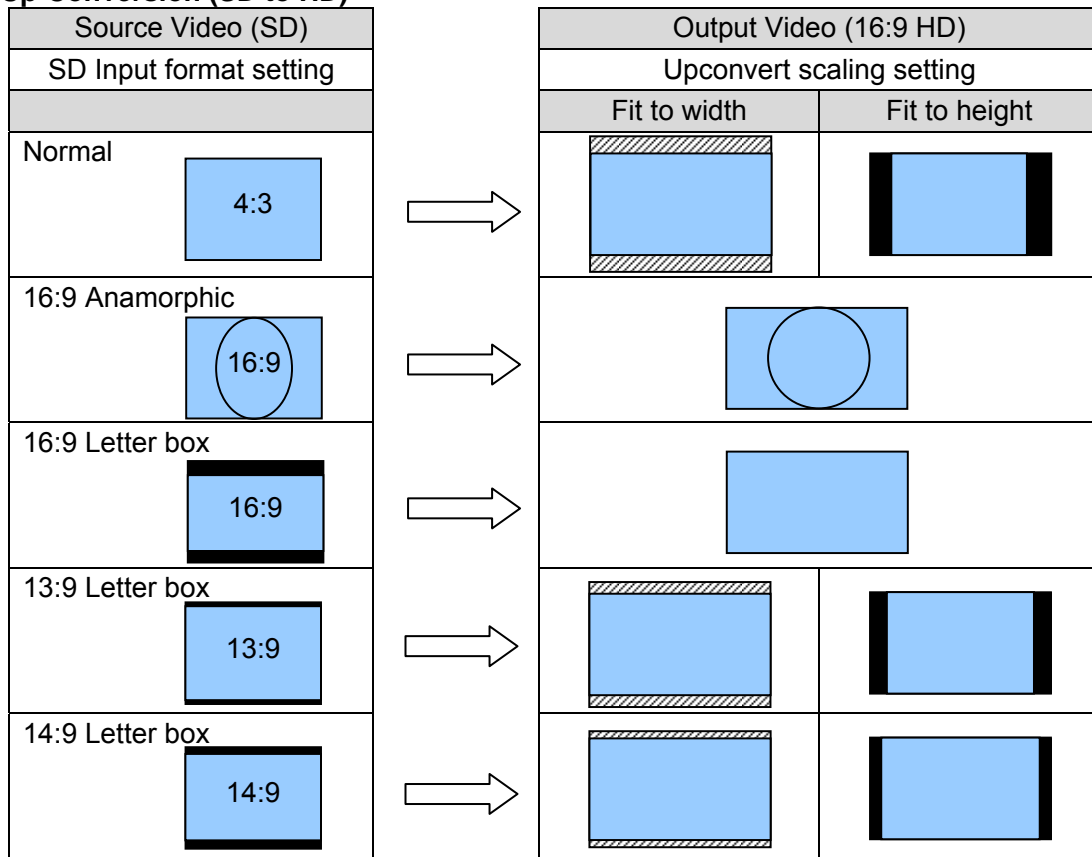

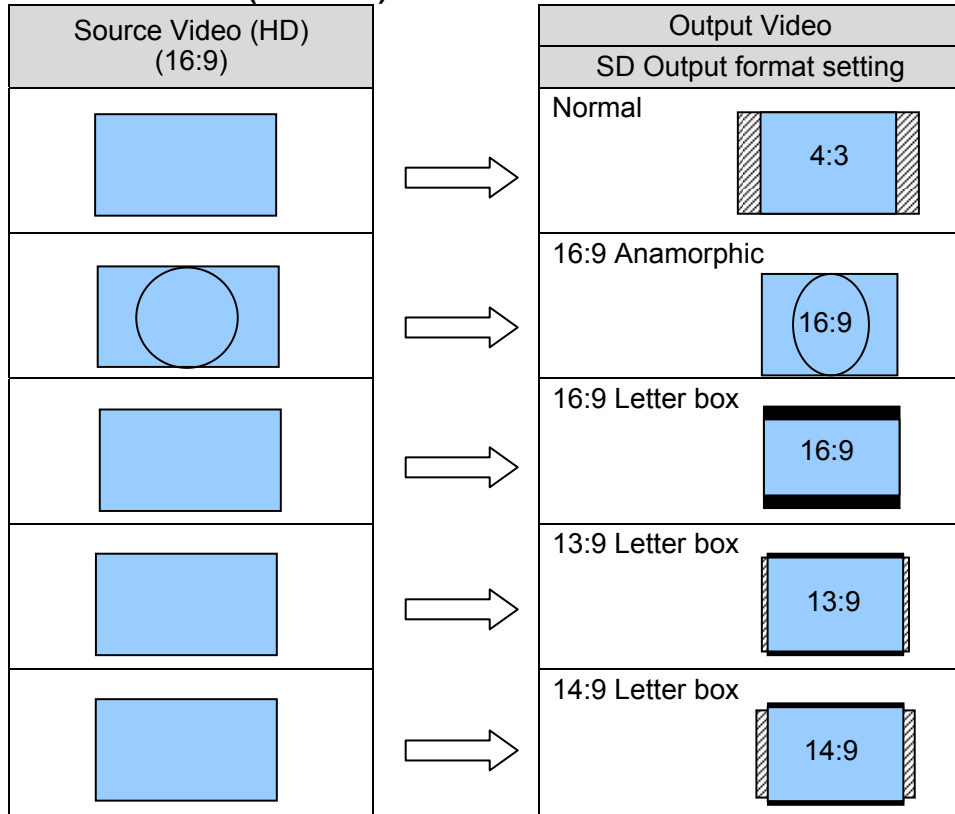

Down-Conversion (HD to SD)

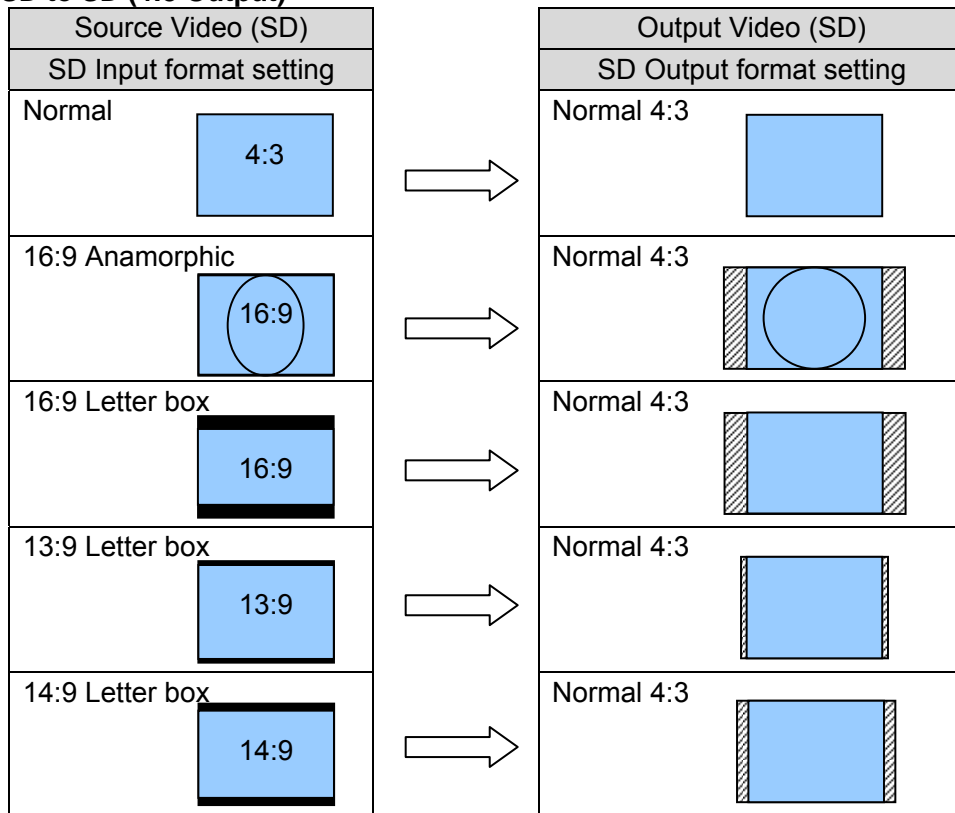

SD to SD (4:3 Output)

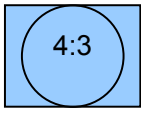
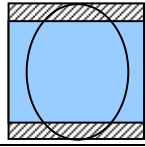
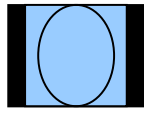
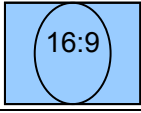
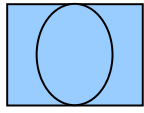
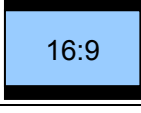
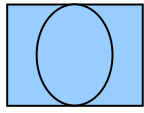

SD to SD Conversion (16:9 Anamorphic Output)

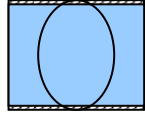
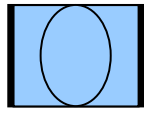
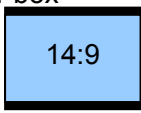
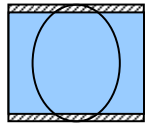
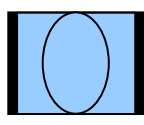
Source Video (SD)		Output Video		
SD Input format setting		SD Output format setting	Upconvert scaling setting	
			Fit to width	Fit to height
Normal 	→	16:9 Anamorphic		
16:9 Anamorphic 	→	16:9 Anamorphic		
16:9 Letter box 	→	16:9 Anamorphic		
13:9 Letter box 	→	16:9 Anamorphic		
14:9 Letter box 	→	16:9 Anamorphic		

SD to SD Conversion (16:9 Letter Box Output)

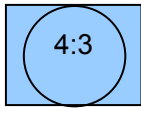
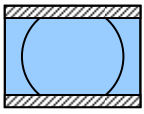
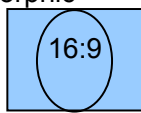
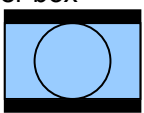
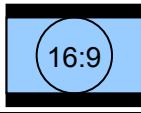
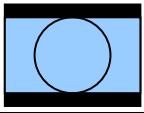
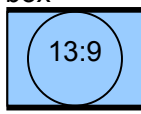
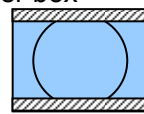
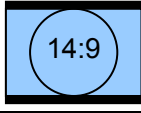
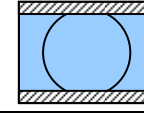
Source Video (SD)		Output Video	
SD Input format setting		SD Output format setting	
Normal 	→	16:9 Letter box	
16:9 Anamorphic 	→	16:9 Letter box	
16:9 Letter box 	→	16:9 Letter box	
13:9 Letter box 	→	16:9 Letter box	
14:9 Letter box 	→	16:9 Letter box	

5-1-3. Composite

Menu		Default	Setting Range	Description
No.	Parameter			
02	CVBS Input/Output			
02-01	CVBS Output standard	PAL/NTSC	PAL/NTSC PALN/PALM PAL/NTSC-J	Allows you to set the video standard output from the COMPOSITE connector.
02-02	CVBS IN pedestaling	On	Off On	Allows you to select the setup level for when NTSC signal is input into the COMPOSITE input connector. Off: Sets the setup level to 0IRE (Japan). On: Sets the setup level to 7.5IRE (e.g., US).

5-1-4. Motion Compensation

Menu		Default	Setting Range (Units)	Description
No.	Parameter			
03	Motion compensation			
03-01	Motion process	On	Off, On	Allows you to set convert mode. Off: Performs linear conversion. On: Performs motion compensation.
03-02	Motion sense	On	Off, On	Improves vertical resolution for conversion. However, the image may appear incorrectly depending on the source.
03-03	Caption bias	3	0 to 7 (1 level)	Allows you to set motion compensation for text. Higher values favor small picture elements with uniform motion such as scrolling captions. Lower values increase the motion process sensitivity for picture elements with fast motion.

5-1-5. Enhancer

Menu		Default	Setting Range	Description
No.	Parameter			
04	Enhancer			
04-01	H Enhancer detail	Normal	Soft 2 Soft 1 Normal Sharp 1 Sharp 2	Allows you to set the horizontal enhancer. Soft 2: Reduces horizontal bandwidth from a lower cut-off frequency. Soft1: Reduces horizontal bandwidth from a higher cut-off frequency (less energy loss). Normal: No enhancer will be applied. Sharp1: Increases horizontal bandwidth from a higher cut-off frequency. Most effective when downconverting. Sharp2: Increases horizontal bandwidth from a lower cut-off frequency. Most effective when downconverting. Can cause alias.
04-02	H Enhancer sharpness	Normal	Low 2 Low 1 Normal High 1 High 2	Allows you to set the H Enhancer frequency range. If H Enhancer detail is set to Normal , this setting is disabled. Low 2: Wide transition region around cut-off frequency. Low 1: Less wide transition region around cut-off frequency. Normal: Standard transition width. High 1: Less narrow transition around cut-off frequency High 2: Narrow transition around cut-off frequency.
04-03	V Enhancer frequency	Medium	Low Medium High	Allows you to set the V Enhancer frequency range. If V Enhancer detail is set to Normal , this setting is disabled. Low: Vertical aperture with low cut-off frequency. Medium: Vertical aperture with medium to high cut-off frequency. High: Vertical aperture with high cut-off frequency.
04-04	V Enhancer level	Normal	Soft Normal Sharp 1 Sharp 2 Sharp 3	Allows you to set the vertical enhancer. Soft: Reduces vertical bandwidth. Normal: No enhancer will be applied. Sharp 1: Increases vertical bandwidth (low). Sharp 2: Increases vertical bandwidth (medium). Sharp 3: Increases vertical bandwidth (high).

5-1-6. Film

Menu		Default	Setting Range	Description
No.	Parameter			
05	Film			
05-01	Film cadence insert	Off	Off, On	Allows you to set the conversion method for when converting from 1080/23.98PsF to 1080/59.94i. Off: Performs motion compensation or linear conversion. On: Performs 3:2 pulldown conversion.

5-1-7. Audio Delay

Menu		Default	Setting Range (Units)	Description
No.	Parameter			
23	SDI audio delay			
23-01	Audio delay unit	0	-40 to 200 ms (1 ms)	Allows you to apply a common amount of audio delay to all output channels.

5-1-8. Input Select

Menu		Default	Setting Range	Description
No.	Parameter			
40	System setting			
40-01	Input select	HD/SD-SDI	HD/SD-SDI CVBS	Allows you to select an input connector for conversion. HD/SD-SDI: Converts the signal input into the SDI connector. CVBS: Converts the signal input into the COMPOSITE connector.
40-02	Sync mode	Off	Off, On	Setting Sync mode to On minimizes the delay to less than 1 frame (between lines to 1 frame) when the input and output videos are the same format. The VANC data will be bypassed.

5-1-9. System Phase

Menu		Default	Setting Range (Units)	Description
No.	Parameter			
41	System phase			
41-01	System phase H	0	-2063 to 2062 (1 clock)	Allows you to adjust video phase. If Module BNC or Chassis BNC is selected under 43-01 Reference Source , aligns with genlock signal. If Input (SDI) is selected, aligns with video input signal. The settings are adjusted in clocks and lines of the system format, instead of the genlock signal. For example, if 1080/59.94i video is locked to B.B., the system phase settings are adjusted in clocks and lines of the 1080/59.94i format. The setting ranges are as shown below. -1100 to 0 to +1100 clk (horizontal) -563 to 0 to +563 Line (vertical)
41-02	System phase V	0	-563 to 562 (1 line)	

5-1-10. Output

Menu		Default	Setting Range	Description
No.	Parameter			
42	Output			
42-01	Output standard	525/60	Auto 625/50 525/60 720/50p 720/59.94p 1080/50i 1080/59.94i 1080/23.98PsF	Allows you to select the output signal format. Auto: Automatically changes the output signal format according to the input signal. Only the input signal frame rate will be converted and the image size will not be changed. 1080/50i (input) > 1080/59.94i (output) 1080/59.94i(input) > 1080/50i (output) 720/50p (input) > 720/59.94p (output) 720/59.94p(input) > 720/50p (output) 625/50 (input) > 525/60 (output) 525/60 (input) > 625/50 (output)

5-1-11. Reference

The Reference menu allows you to select a reference signal for video outputs. With BB input, the UFM-30FRC gen-locks signals horizontally (H lock), but does not correct subcarrier phase shifts.

Menu		Default	Setting Range	Description
No.	Parameter			
43	Reference			
43-01	Reference source	Free	Module BNC Chassis BNC Input (SDI) Free	<p>Module BNC: Outputs videos synchronized with the reference signal input into the GENLOCK IN connector on the UFM-30FRC.</p> <p>Chassis BNC: Outputs videos synchronized with the reference signal input into the GENLOCK IN connector on the UFM frame.</p> <p>Input (SDI): Outputs videos synchronized with the video input.</p> <p>Free: Outputs videos in free run mode.</p>

5-1-12. Closed Caption

Menu		Default	Setting Range	Description
No.	Parameter			
44	Closed caption			
44-01	Closed caption 608	Off	Off, On	When converting from 1080/59.94i or 525/60 to 525/60, you can select On (pass) or Off (blank) for the input video that contains CC (closed caption) data.

5-1-13. Test Signal

Menu		Default	Setting Range	Description
No.	Parameter			
60	Test signal			
60-01	Video test signal	Off	Off Black Ramp Bars	Allows you to select a test signal to output.

5-1-14. System Status (Display Only)

Menu		Default	Setting Range	Description
No.	Parameter			
80	System status			
80-01	Input signal		Unlocked Loss 625/50 525/60 720/50p 720/59.94p 1080/50i 1080/59.94i 1080/23.98PsF	Displays the input signal status. Displays the input signal format if the signal is present properly. Unlocked: Invalid signal is present. Loss: No input signal is present or signal level is too low.
80-02	Output signal		625/50 525/60 720/50p 720/59.94p 1080/50i 1080/59.94i 1080/23.98PsF	Displays the signal format being output from the SDI output connector.
80-03	Reference standard		Loss Unlock 625/50 525/60 720/50p 720/59.94p 1080/50i 1080/59.94i 1080/23.98PsF	Displays the reference signal status. If a supported reference signal is present, the reference signal format will be displayed. Unlocked: An unsupported reference signal is present. Loss: No reference signal is present, signal level is too low, or 43-01 Reference Source is set to Free .

5-1-15. SDI Audio Status (Display Only)

Menu		Setting Range	Description
No.	Parameter		
81	SDI audio status		
81-01 81-08	SDI Input status ch1/2 SDI Input status ch15/16	Loss PCM NonPCM	Displays the SDI embedded audio status. Loss: No audio is present. PCM: Uncompressed linear PCM audio is present. NonPCM: Compressed audio such as AC-3 is present.

5-1-16. Module Information (Display Only)

Menu		Setting Range	Description
No.	Parameter		
83	Module information		
83-01	Slot number	0 to 22	Displays the slot number of the installed module.
83-02	CPU Version information	*.**	Displays the CPU version.
83-03	FPGA Version information	****	Displays the FPGA version.
83-04	Fan alarm	Normal Stopped	Displays the on-board cooling fan status.
83-05	Temperature alarm	Normal Error	Displays an "Error" message when the board temperature reaches the warning threshold.

6. Processing Delay

The amount of delay caused by input and output combinations and sync settings are described below.

Output Format \ Input Format	1080/59.94i	1080/50i	1080/23.98PsF	720/59.94p	720/50p	525/60 (SD-SDI)	625/50 (SD-SDI)	NTSC (Composite)	PAL (Composite)
1080/59.94i	F1	M	M	U1	M	U1	M	U1	M
1080/50i	M	F2	M	M	U2	M	U2	M	U2
1080/23.98PsF	M	M	F3	M	M	M	M	M	M
720/59.94p	U1	M	M	F1	M	U1	M	U1	M
720/50p	M	U2	M	M	F2	M	U2	M	U2
525/60 (SD-SDI)	U1	M	M	U1	M	F1	M	U1	M
625/50 (SD-SDI)	M	U2	M	M	U2	M	F2	M	U2
NTSC (Composite)	U1	M	M	U1	M	U1	M	F1	M
PAL (Composite)	M	U2	M	M	U2	M	U2	M	F2

◆ Video processing delay

M	110 ms typical	
U1	Ref lock/Free Run: 50.1 to 83.5 ms	Input lock (SDI): 51.1 ms
U2	Ref lock/Free Run: 60 to 100 ms	Input lock (SDI): 61 ms
F1	Ref lock/Free Run: 1 to 33.3 ms	Input lock (SDI): 1 ms or less
F2	Ref lock/Free Run: 1 to 40 ms	Input lock (SDI): 1 ms or less
F3	Ref lock/Free Run: 1 to 41.7 ms	Input lock (SDI): 1 ms or less

◆ Audio processing delay

M	110ms typical	
U1	Ref lock/Free Run: 50.1 ms	Input lock(SDI): 34.3 ms
U2	Ref lock/Free Run: 60 ms	Input lock(SDI): 41 ms
F1	Ref lock/Free Run: 16.7 ms	Input lock(SDI): 3 ms or less
F2	Ref lock/Free Run: 20 ms	Input lock(SDI): 3 ms or less
F3	Ref lock/Free Run: 20.8 ms	Input lock(SDI): 3 ms or less

◆ Recommended audio delay values (23-01 Audio delay)

M	0 ms typical	
U1	Ref lock/Free Run: 17 ms	Input lock (SDI): 17 ms
U2	Ref lock/Free Run: 20 ms	Input lock (SDI): 20 ms
F1	Ref lock/Free Run: 0 ms	Input lock (SDI): 0 ms
F2	Ref lock/Free Run: 0 ms	Input lock (SDI): 0 ms
F3	Ref lock/Free Run: 0 ms	Input lock (SDI): 0 ms

The F1-F3 values shown above are for when **40-02 Sync mode** is set to **On**.

7. Conversion Examples

7-1. SD to HD (Without Genlock)

This operation example shows how to convert SD-SDI video to HD-SDI video without using a genlock signal. The 4:3 SD video is converted to 16:9 HD video by **horizontally filling** a 16:9 screen.

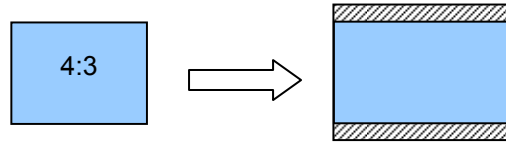

◆ Connection

- 1) Input an SD-SDI signal into the **INPUT-SDI** port.
- 2) Connect the **OUTPUT-SDI 1** or **OUTPUT-SDI 2** port to a waveform monitor or an SDI monitor.
- 3) Turn on the power of the UFM frame.

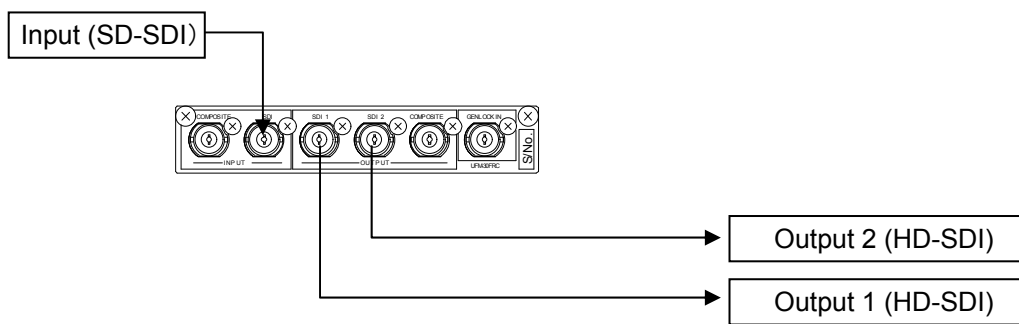

◆ Conversion Settings

Make settings as shown in the table below. See sections 4-2 "Menu Operation" and 5. "Menu List" for details on menu operation.

Menu	Item	Setting	Description	Refer To
System setting	Input select	HD/SD-SDI	Selects SDI for input port. The video format is automatically set.	5-1-8
Output	Output standard	720P, 1080i	Selects 1080i or 720P for output video format.	5-1-10
Reference	Reference source	Free	Sets reference mode to Free (Free Run).	5-1-11
ARC Process	SD Input format	Normal	Specifies aspect ratio of input to 4:3 .	5-1-2
	Upconvert scaling	Fit to width	If set to Fit to width , the aspect ratio of the video is preserved, the right and left edges are fitted and the top and bottom regions are cut off.	

7-2. SD to HD (with Genlock)

This operation example shows how to convert SD-SDI video to HD-SDI video using a genlock signal that is input into the UFM frame. The 4:3 SD video is converted to 16:9 HD video by **vertically filling** a 16:9 screen (pillar box type). The output video is synchronized with the genlock signal. Adjust the genlock phase in the menu.

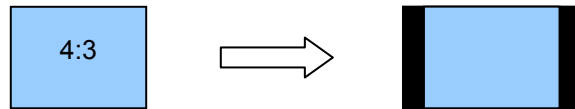

◆ Connection

- 1) Input an SD-SDI signal into the **INPUT-SDI** port.
- 2) Connect the **OUTPUT-SDI 1** port or **OUTPUT-SDI 2** port to a waveform monitor or an SDI monitor.
- 4) Input a genlock signal (BB) to the UFM frame.
- 5) Turn on the power of the UFM frame.

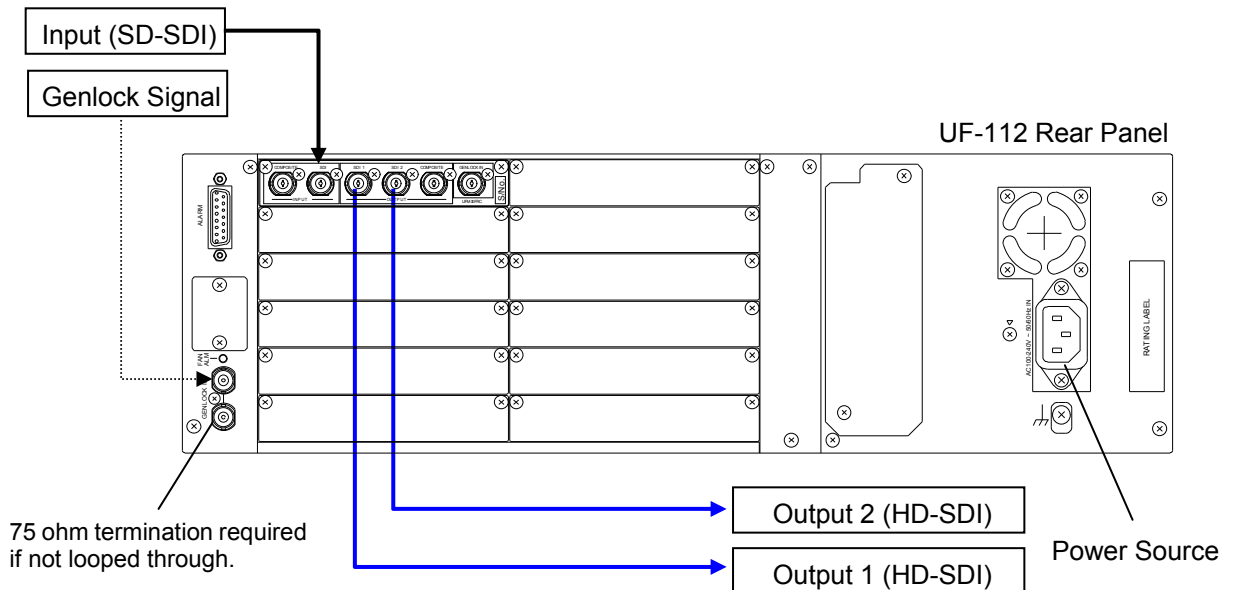

◆ Conversion Settings

Set settings as shown in the table below. See sections 4-2. "Menu Operation" and 5. "Menu List" for details on menu operation.

Menu	Parameter	Setting	Description	Refer To
System setting	Input select	HD/SD-SDI	Selects SDI for the input port. The video format is automatically set.	5-1-8
Output	Output standard	720P, 1080i	Selects 1080i or 720P for the output video format.	5-1-10
Reference	Reference source	Chassis BNC	Selects the reference signal input into the UFM frame for synchronization. The reference signal type will be automatically recognized.	5-1-11
System phase	System phase H	(±1/2H)	Adjusts the horizontal phase and vertical phase settings while monitoring the waveform monitor.	5-1-9
	System phase V	(±1/2V)		
ARC Process	SD Input format	Normal	Sets the aspect ratio to 4:3 for the input video.	5-1-2
	Upconvert scaling	Fit to height	When set to Fit to height , the aspect ratio of the video is preserved, the top and bottom edges are fitted and black bars are added to the left and right edges.	

7-3. HD to HD (Frame Rate Conversion)

This operation example shows how to convert the frame rate between HD videos.

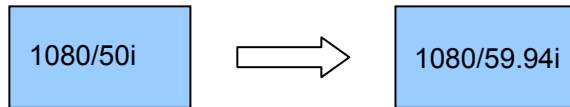

◆ Connction

- 1) Input an HD-SDI signal into the **INPUT-SDI** port.
- 2) Connect the **OUTPUT-SDI 1** or **OUTPUT-SDI 2** port to a waveform or SDI monitor.
- 3) Turn on the power of the UFM frame

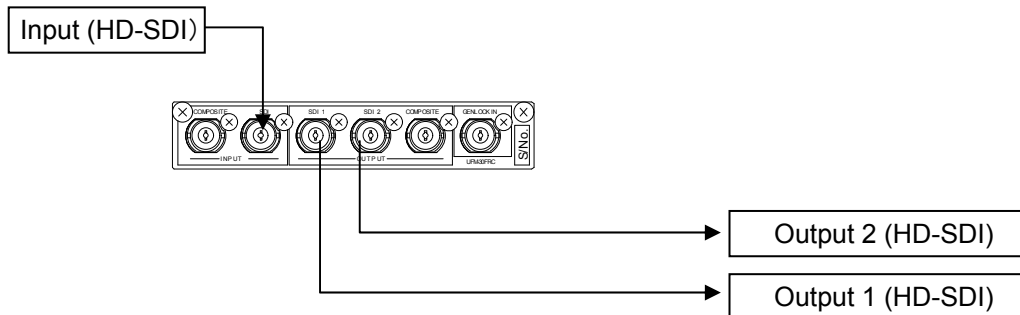

◆ Conversion Settings

Set settings as shown in the table below. See sections 4-2. "Menu Operation" and 5. "Menu List" for details on menu operation.

Menu	Parameter	Setting	Description	Refer To
System setting	Input select	HD/SD-SDI	Selects SDI for the input port. The video format is automatically set.	5-1-8
Output	Output standard	1080/59.94i (or Auto)	Selects 1080/59.94i or Auto for the output video format. If set to Auto , only the input signal frame rate will be converted and the image size will remain unchanged.	5-1-10
Reference	Reference source	Free	Sets reference mode to Free (free run).	5-1-11

8. Troubleshooting

If any of the following problems occur while operating the UFM-30FRC, before assuming a unit malfunction has occurred, follow the troubleshooting procedures below to see if the problem can be corrected.

IMPORTANT

If the problem is not corrected by performing the procedures below, turn the unit off and then on again. If this still does not correct the problem, contact your dealer.

Problem	Check	Action
Unable to output video.	Does the connected device support the video format?	Verify that the connected device supports the format being used.
	Is the Input select setting the same as that of the connected connector?	Verify that the correct connector (SDI: HD/SD-SDI or COMPOSITE: CVBS) is selected under Input select .

9. Specifications and Dimensions

9-1. Specifications

Video Formats	HD-SDI: 1080/59.94i, 1080/50i, 1080/23.98PsF, 720/59.94p, 720/50p SD-SDI: 525/60 (NTSC), 625/50 (PAL)
Video Input	Composite: NTSC or PAL, 1.0 Vp-p, 75Ω, BNC x 1 HD-SDI: 1.5 Gbps or SD-SDI: 270 Mbps, 75Ω, BNC x 1
Video Output	HD-SDI: 1.5 Gbps or SD-SDI: 270 Mbps, 75Ω, BNC x 1
Monitor Output	NTSC or PAL, 1.0 Vp-p, 75Ω, BNC x 1
Quantization	Y: 10-bit, C: 10-bit
Sampling Frequency	Y: 74.25 MHz or 74.25/1.001 MHz or 13.5 MHz C: 37.125 MHz or 37.125/1.001 MHz or 6.75 MHz
Internal Processing	2 inputs (COMPOSITE or SDI) > 1 process > 2 outputs
Input Cable Length (5C-FB or equivalent)	HD-SDI: Approx. 140 m SD-SDI: Approx. 300 m
Genlock Input	BB: 0.429 Vp-p (NTSC), 0.45 Vp-p (PAL) or Tri-level sync 0.6V p-p (BB is used as Bi-level sync)
Reference Mode	Reference lock mode, Input mode, Free run mode
Phase Adjustment	Reference lock mode: Horizontal: $\pm 1/2H$
Process Amp	Setup level: -14.0 to 14.0% (0.1% steps) Y level: 70.0 to 130.0% (1.0% steps) Chroma level: 70.0 to 130.0% (1.0% steps)
Audio Input	Embedded audio: 16 channels (Group 1-4), 48 kHz
Audio Output	Embedded audio: 16 channels (Group 1-4), 48 kHz
Temperature	0°C - 40°C
Humidity	30% - 85% (no condensation)
Power	+24 VDC (Supplied from UFM frame)
Consumption	0.64 A
Dimensions	Front module: 106 (W) x 310.6 (D) (mm) Rear module: 108.5 (W) x 71 (D) x 20 (H) (mm)
Weight	0.5 kg
Required slot	1 slot
Consumables	Cooling fan: Replace every 5 years at normal temperature.

9-2. External Dimensions

(All dimensions in mm.)

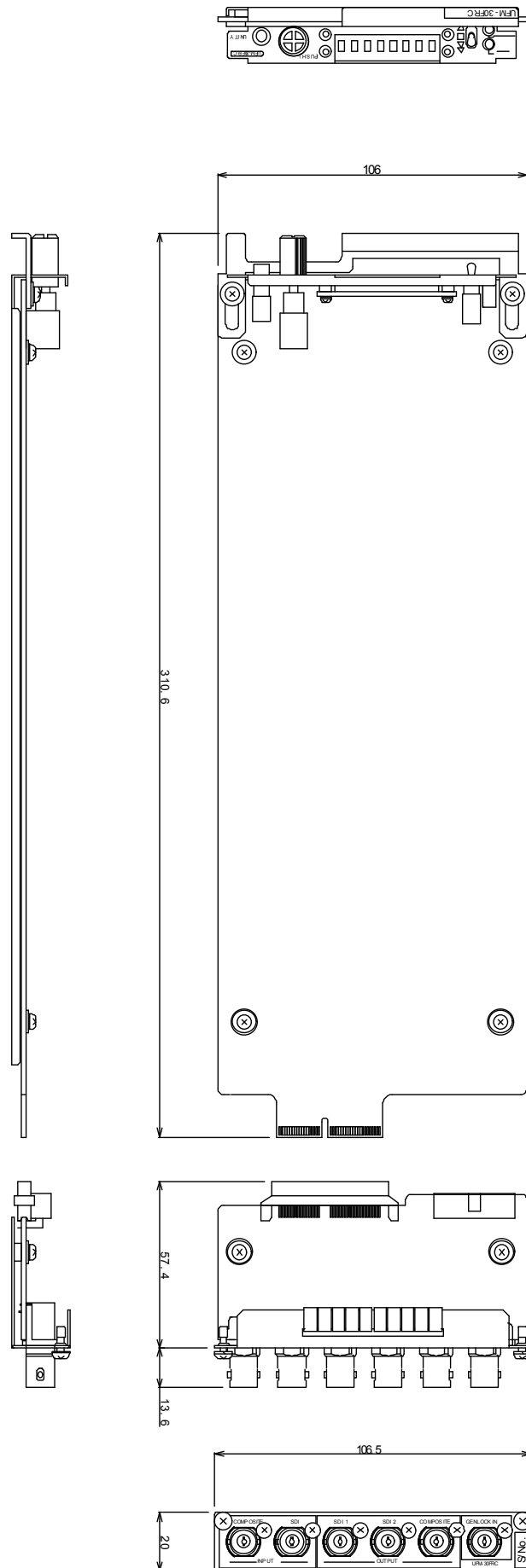



FOR-A COMPANY LIMITED

Head Office 3-8-1 Ebisu, Shibuya-ku, Tokyo 150-0013, Japan
Overseas Division Phone: +81(0)3-3446-3936, Fax: +81(0)3-3446-1470
Japan Branch Offices Osaka/Okinawa/Fukuoka/Hiroshima/Nagoya/Sendai/Sapporo
R&D/Production Sakura Center/Sapporo Center

FOR-A America Corporate Office

11155 Knott Ave., Suite G&H, Cypress, CA 90630, USA
Phone: +1-714-894-3311 Fax: +1-714-894-5399

FOR-A America East Coast Office

2 Executive Drive, Suite 670, Fort Lee Executive Park, Fort Lee, NJ 07024, USA
Phone: +1-201-944-1120 Fax : +1-201-944-1132

FOR-A America Distribution & Service Center

2400 N.E. Waldo Road, Gainesville, FL 32609, USA
Phone: +1-352-371-1505 Fax: +1-352-378-5320

FOR-A Corporation of Canada

346A Queen Street West, Toronto, Ontario M5V 2A2, Canada
Phone: +1-416-977-0343 Fax: +1-416-977-0657

FOR-A Latin America & the Caribbean

5200 Blue Lagoon Drive, Suite 760, Miami, FL 33126, USA
Phone: +1-305-931-1700 Fax: +1-305-264-7890

FOR-A UK Limited

UNIT C71, Barwell Business Park, Leatherhead Road, Chessington Surrey, KT9 2NY, UK
Phone: +44(0)20-8391-7979 Fax: +44(0)20-8391-7978

FOR-A Italia S.r.l.

Via Volturmo 37, 20047 Brugherio MB, Italy
Phone: +39-039-881-086/103 Fax: +39-039-878-140

FOR-A Corporation of Korea

1007, 57-5, Yangsan-ro, Yeongdeungpo-gu, Seoul 150-103, Korea
Phone: +82(0)2-2637-0761 Fax: +82(0)2-2637-0760

FOR-A China Limited

708B Huateng Bldg., No. 302, 3 District, Jinsong, Chaoyang, Beijing 100021, China
Phone: +86(0)10-8721-6023 Fax: +86(0)10-8721-6033

FOR-A Middle East-Africa Office

Jebel Ali Free Zone, LOB-16, Office 619, P. O. Box: 261914 Dubai, UAE
Phone: +971 4 887 6712 Fax: +971 4 887 6713

*The contents of this manual are subject to change without notice.