

OPERATION MANUAL

IVS-700HS



Video Stabilizer

1st Edition - Rev.2



Precautions

Important Safety Warnings



[Power]

 Caution	Operate unit only on the specified supply voltage.
	Disconnect power cord by connector only. Do not pull on cable portion.
 Stop	Do not place or drop heavy or sharp-edged objects on power cord. A damaged cord can cause fire or electrical shock hazards. Regularly check power cord for excessive wear or damage to avoid possible fire / electrical hazards.

[Grounding]

 Caution	Ensure unit is properly grounded at all times to prevent electrical shock hazard.
 Hazard	Do not ground the unit to gas lines, units, or fixtures of an explosive or dangerous nature.
 Caution	Ensure power cord is firmly plugged into AC outlet.



[Operation]

 Hazard	Do not operate unit in hazardous or potentially explosive atmospheres. Doing so could result in fire, explosion, or other dangerous results.
 Hazard	Do not allow liquids, metal pieces, or other foreign materials to enter the unit. Doing so could result in fire, other hazards, or unit malfunction.
	If foreign material does enter the unit, turn power off and disconnect power cord immediately . Remove material and contact authorized service representative if damage has occurred.

[Transportation]

 Caution	Handle with care to avoid shocks in transit. Shocks may cause malfunction. When you need to transport the unit, use the original packing materials or alternate adequate packing.
--	--

[Circuitry Access]

 A black circle with a white lightning bolt and a plug symbol, with a diagonal slash through it, indicating no power.	<p>Do not remove covers, panels, casing, or access circuitry with power applied to the unit! Turn power off and disconnect power cord prior to removal. Internal servicing / adjustment of unit should only be performed by qualified personnel.</p>
 A black circle with a white hand symbol and a diagonal slash through it, indicating no touch. Stop	<p>Do not touch any parts / circuitry with a high heat factor. Capacitors can retain enough electric charge to cause mild to serious shock, even after power is disconnected. Capacitors associated with the power supply are especially hazardous. Avoid contact with any capacitors.</p>
 A black triangle with a white lightning bolt and a flame symbol, indicating a hazard. Hazard	<p>Unit should not be operated or stored with cover, panels, and / or casing removed. Operating unit with circuitry exposed could result in electric shock / fire hazards or unit malfunction.</p>

[Potential Hazards]

 A black triangle with a white lightning bolt symbol, indicating caution. Caution	<p>If abnormal smells or noises are noticed coming from the unit, turn power off immediately and disconnect power cord to avoid potentially hazardous conditions. If problems similar to above occur, contact authorized service representative before attempting to again operate unit.</p>
--	---

[Consumables]

 A black triangle with a white exclamation mark symbol, indicating caution. Caution	<p>The consumables used in unit must be replaced periodically. For further details on which parts are consumables and when they should be replaced, refer to the specifications at the end of the Operation Manual. Since the service life of the consumables varies greatly depending on the environment in which they are used, they should be replaced at an early date. For details on replacing the consumables, contact your dealer.</p>
--	--

[Rubber Feet]

 A black circle with a white exclamation mark symbol, indicating caution. Caution	<p>If this product has come with rubber feet attached by screws, do not insert the screws again without rubber feet after removing the rubber feet and screws. It may cause damage to the internal circuits or components of the unit. To install the rubber feet again to the unit, do not use other than the supplied rubber feet and screws.</p>
--	---

Upon Receipt

Unpacking

IVS-700HS units and their accessories are fully inspected and adjusted prior to shipment. Operation can be performed immediately upon completing all required connections and operational settings.

Check your received items against the packing lists below.

ITEM	QTY	REMARKS
IVS-700HS	1	
AC Cable	1	
Rack Mount Brackets	1 pr.	EIA standard type
Operation Manual	1	

Check

Check to ensure no damage has occurred during shipment. If damage has occurred, or items are missing, inform your supplier immediately.

Rack Mounting

The IVS-700HS can be mounted to EIA standard rack units. When rack mounting a unit, remove the rubber feet and use the accessory rack mount brackets (rack ears).

Table of Contents

1. Prior to Starting.....	1
1-1. Welcome	1
1-2. About the IVS-700HS	1
1-3. Usage Notes	2
1-4. About This Manual.....	2
2. Panel Descriptions	3
2-1. Front Panel.....	3
2-2. Rear Panel	4
3. Connection	6
4. Power ON.....	7
4-1. Startup screen	7
4-2. Menu Screen.....	7
5. Operation	9
5-1. Menu List.....	9
5-1-1. Operation Menu.....	9
5-1-2. System Menu	10
5-2. Operation	11
5-2-1. Button Operation	11
5-2-2. Menu Operations.....	12
5-3. UNITY	14
5-3-1. Setting Parameters to UNITY	14
5-3-2. Setting UNITY Values.....	14
6. Operation Setting	16
6-1. Video Shaking Correction (Stabilize)	16
6-2. Correction Level	16
6-3. Motion Filter	17
6-4. Enhance	17
6-5. Anti-alias Filter.....	18
6-6. Freeze	18
6-7. Effective Area	18
6-8. Correction Area	20
6-9. Motion Detect Area.....	21
6-10. Video Clip Level (Clip Setting).....	22
6-11. Video Signal Standard (Signal Select).....	22
6-12. Sync Mode (Synchronous).....	23
7. The Other Settings	24
7-1. OPERATE / BY-PASS	24
7-1-1. OPERATE	24
7-1-2. BY-PASS	24
7-2. OPERATION MODE.....	25
7-2-1. Menu Lock.....	25
7-2-2. Button Lock	25
7-2-3. Serial and GPI Mode Setting.....	25
7-3. Returning to Default	26
8. Remote Control	27
8-1. RS-232C/422 Connector	27

8-1-1. If RS-232C Used.....	27
8-1-2. If RS-422 Used	28
8-1-3. Communication Protocol.....	29
8-1-4. Command List.....	30
8-1-5. Error Message	32
8-2. GPI Connector	33
8-2-1. GPI Terminal Equivalent Circuit	34
9. If Problems Occur	35
10. Specifications & Dimensions	36
10-1. Unit Specifications.....	36
10-2. External Dimensions	37

1. Prior to Starting

1-1. Welcome

Congratulations! By purchasing IVS-700HS you have entered the world of FOR-A and its many innovative products. Thank you for your patronage and we hope you will turn to FOR-A products again and again to satisfy your video and audio needs.

FOR-A provides a wide range of products, from basic support units to complex system controllers, which have been increasingly joined by products for computer video based systems. Whatever your needs, talk to your FOR-A representative. We will do our best to be of continuing service to you.

1-2. About the IVS-700HS

The IVS-700HS is a multi-bit rate and multi-format digital video stabilizer optimized for broadcasting applications. It makes electrical corrections for video shaking occurring with a camera. It corrects the unsteadiness alone while maintaining the panning and tilt movements of the camera. It can also correct unsteadiness on video images for TV programs such as headline news, traffic and weather reports. The IVS-700HS is easy to install and incorporate into existing systems.

Features

- Accepts both HD SDI and SD SDI digital component signals
- Capable of realtime image stabilization (2 frame delay)
- Corrects only the unsteadiness while automatically recognizing panning and tilt movements
- Video stabilization available both in LIVE and VCR videos
- Capable of correcting an input signal up to 40% in the vertical/horizontal direction with respect to the screen
- Provides precise sub-pixel level correction
- Simple design - works by simply connecting the video cable without any special connections
- Stabilizes only the data in the active area and keeps all the blanking data unchanged
- Able to pass through the blanking data while compensating the processing delay
- RS-232C/RS-422 or GPI remote control available

1-3. Usage Notes

- ◆ When shooting with the camera, use the highest possible shutter speed. Shooting moving objects with a slower shutter speed will result in a blurred and low-resolution image. A shutter speed of 1/240 sec. or less is recommended. This value, however, varies according to shooting subjects, shaking speed and other environments.

- ◆ Note that IVS-700HS may not get proper results with some video images as below.
 - 1) Images that appear flat
Example: Images with uniform illumination of a wall or floor

 - 2) Images with changing illumination in a single direction
Example: Test signals such as Ramp/Color bar where the luminance level only changes horizontally, but not vertically.

 - 3) Images with alternating changes in illumination
Example: Images where an object such as a blind has changing light intensity that varies repeatedly at the same interval.

 - 4) Images with multiple movements in different directions
Example: Images where a big object crosses in front of the camera.

1-4. About This Manual

This manual is intended to help the user easily operate the IVS-700HS and make full use of its functions during operations. Before connecting or operating your unit, read this operation manual thoroughly to ensure you understand the product. After reading, it is important to keep this manual in a safe place and available for reference.

2. Panel Descriptions

2-1. Front Panel

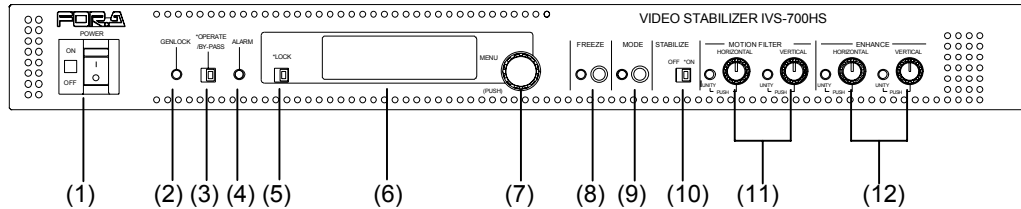

(1) Power switch and indicator

Switch used to turn unit power ON / OFF. Power indicator will be lit green whenever power switch is set to ON and power applied to the unit.

(2) GENLOCK Indicator

Indicator lights whenever IVS-700HS signal is synced with external reference signal input to rear panel GENLOCK connector.

Indicator	Indication	Sync Signal
Lit	IVS-700HS signal outputs synced to external signal input.	External reference signal
Not lit	No external reference signal input connected (or input level too low). Internal timing signal used for reference.	Internal reference signal

(3) OPERATE/BY-PASS toggle switch

OPERATE (to left, light ON): Performs the shaking correction and outputs the corrected signals.

BY-PASS (to right, light OFF): Outputs the input signals without performing correction. See section 7-1. "OPERATE / BY-PASS."

(4) ALARM indicator

Indicator lights whenever the fan failure occurs.

(5) LOCK/OPERATE toggle switch

Right side: The switch is set to Menu mode and menu settings can be made.

Left side: The switch is set to Menu Lock mode and menu settings cannot be made (lit orange).

The display panel shows "LOCK" when the switch is set to Menu Lock mode.

(6) Display panel (Vacuum-Fluorescent Display)

Two line, 16-character per line, bright vacuum fluorescent display. This is used for both message and menu display.

(7) Menu Control

Used to make menu settings.

Parameters are changed (by turning the control clockwise or counterclockwise) and set (by pressing the control) while viewing the displayed information on the display panel (6).

(8) FREEZE

Used to switch freeze operation ON/OFF. See section 6-6. "Freeze."
Left indicator lights whenever the FREEZE operation is set to ON.

(9) MODE

Used to enter the System Mode. Press and hold down the MODE button for several seconds to enable the system mode. The LED lights up to indicate the unit is operating in system mode. Press the button again to return to the normal operation mode. See section 5-1-2. "System Menu."

IMPORTANT

Be aware that when in the System Mode, a rectangle or a masked region that indicate the Effective Area, the Correction Area or the Motion Detect Area will be displayed on VIDEO OUT output screen. See section 4-2 "Menu Screen."

(10) STABILIZE

Used to switch video shaking correction ON/OFF. See section 6-1 "Video Shaking Correction (Stabilize)."

ON (to right, indicator light ON): Video shaking correction is performed.
OFF (to left, indicator light OFF): Video shaking correction is not performed.

(11) MOTION FILTER

HORIZONTAL: Used to adjust the horizontal motion filter for smooth correction.
VERTICAL: Used to adjust the vertical motion filter for smooth correction.
See section 6-3 "Motion Filter."

The MOTION FILTER can be set by turning the respective control. Each parameter can be set to the factory or user default (UNITY) by pressing the controls. Once the unity default setting is applied, the UNITY indicator at the left lights green. If the control is pressed again, the value can be changed by turning the control. See section 5-3 "UNITY."

(12) ENHANCE

HORIZONTAL: Used to adjust the horizontal edge enhancement.
VERTICAL: Used to adjust the vertical edge enhancement.
See section 6-4 "Enhance."

The ENHANCE can be set by turning the respective control. Each parameter can be set to the factory or user default (UNITY) by pressing the controls. Once the unity default setting is applied, the UNITY indicator at the left lights green. If the control is pressed again, the value can be changed by turning the control. See section 5-3 "UNITY."

2-2. Rear Panel

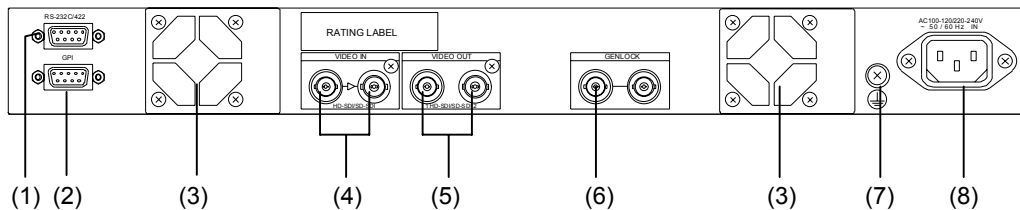

- (1) RS-232C /RS-422
Used for serial control connection. 9-pin D-sub male. (RS-232C/RS-422 selectable.)
See section 8-1 “RS-232C/422 Connector.”
- (2) GPI
Used for GPI control connection. 9-pin D-sub connector, female.
See section 8-2 “GPI Connector.”
- (3) FAN
Used to air cool unit to prevent overheating. Do not block fan intake with other equipment or objects.
- (4) VIDEO IN (HD/SD SDI)
Used for serial digital component video input connection. Right connector is used to active through out.
- (5) VIDEO OUT (HD/SD SDI)1, 2
Used for serial digital component video output connection.
The connectors will output the corrected video input from (4) VIDEO IN if the OPERATE/BY-PASS switch on the front panel is set to OPERATE.
The VIDEO OUT1 outputs the input image directly if the switch is set to BY-PASS or the unit power is OFF. The VIDEO OUT2 doesn't output any images if the switch is set to BY-PASS or the unit power is OFF. See the table below.

VIDEO OUT	Power ON/OFF	OPERATE / BY-PASS Setting	Output Video Image
1	ON	OPERATE	Corrected image
		BY-PASS	Input image (uncorrected)
	OFF	---	Input image (uncorrected)
2	ON	OPERATE	Corrected image
		BY-PASS	None
	OFF	---	None

- (6) GENLOCK
Used for input of external Black Burst or Tri Level sync reference signal. Front panel GENLOCK indicator lights when the GENLOCK signal is input to this connector. Right (loopthru) connector must be 75 ohm terminated if it isn't connected to other system equipment.

IMPORTANT

The genlock input enables to align the horizontal phase of output video. (Phase-lock range: $\pm 1/2H$) The vertical phase lock function is not implemented. So input the reference signal of the same phase as SDI inputs.

- (7) Ground Terminal
Used to ground unit to protect operators against static electricity and / or electrical shock.
- (8) AC IN (AC 100-120/220-240V 50/60Hz)
Used for connection to AC power source via supplied cable.

3. Connection

◆ Standard Connection Example

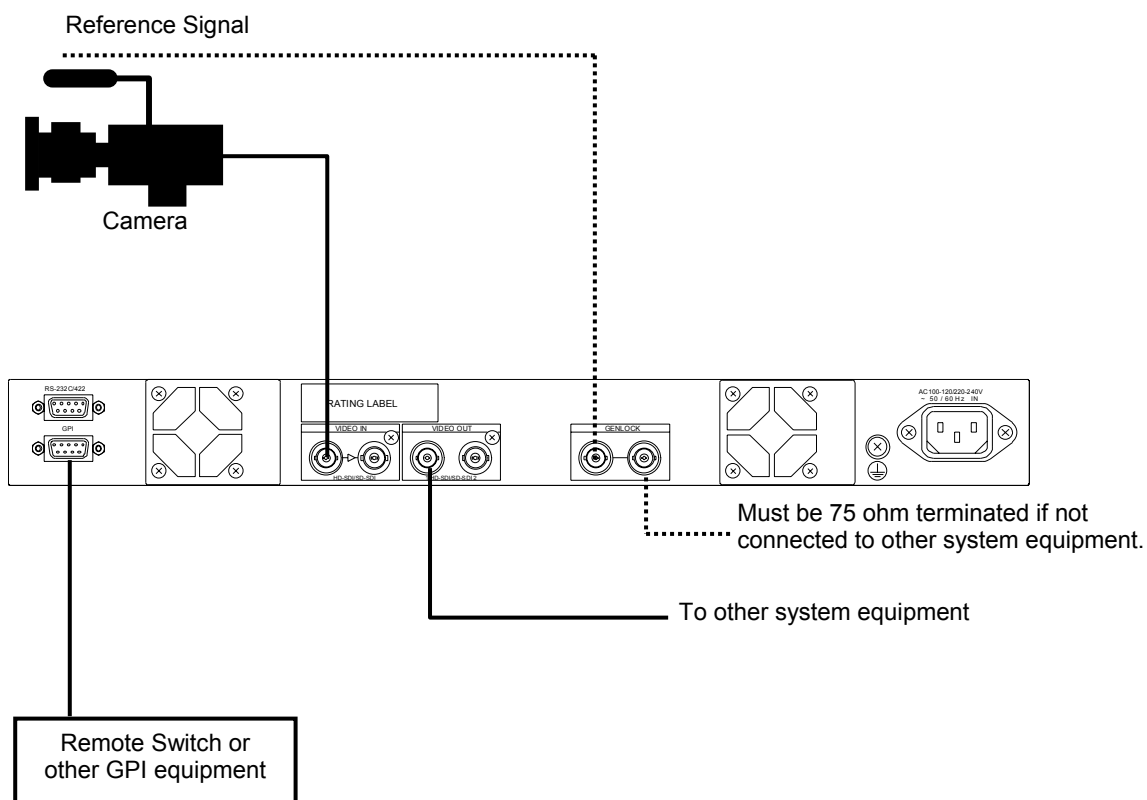

IMPORTANT

The HD/SD SDI VIDEO IN (serial digital component input) connector has an active-through output.

The GENLOCK connector has a loop-through output. The 75 ohm termination is needed if the input reference signal is not looped through.

4. Power ON

4-1. Startup screen

Turn the Power switch to ON after all system connections are complete. The IVS-700HS firmware version is displayed at startup.

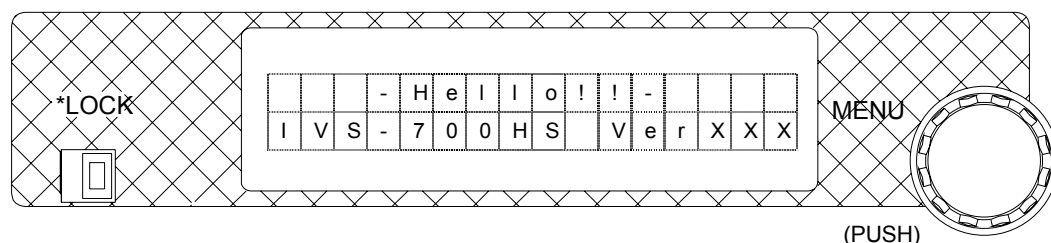

4-2. Menu Screen

Promptly after the startup screen, the menu screen that indicates the current operation mode, the video input status, and the video format selected in the system menu will be displayed on the display panel as the figure below.

O	P	E	R	A	T	E			V	I	D	:	I	n
E	C	M		1	0	8	0	/	5	9	.	9	4	i

Item	Display	Description
Operation Mode	OPERATE	Operates in local mode. All process button and menu controls on the front panel are enabled.
	LOCK	Operates in local mode. However, all menu operations are locked and disabled.
	Serial	Operates in serial mode with RS-232C or RS-422. All process button and menu controls except setting display and "Control" menu setting on the front panel are disabled.
	GPI	Operates in GPI mode. All process button and menu controls except setting display and "Control" menu setting on the front panel are disabled.
Video Input Status	VID: In	Input video signal is present.
	VID: No	No input video signal is present.
	VID: Bp	BY-PASS operation is functioning.
Effective Area	E	Displayed if the Effective Area is not set as the factory made default setting (See section 6-7.).
Correction Area	C	Displayed if the Correction Area is not set as the factory made default setting (See section 6-8.).
MD Area	M	Displayed if the Motion Detection Area is not set as the factory made default setting (See section 6-9.).

Item	Display	Description
Video Format	1080/59.94i 1080/60i 1080/50i 720/60p 720/59.94p 720/50p 525/60 625/50	The video signal format selected in the system menu.

IMPORTANT

When in the System Mode, a rectangle or a masked region that indicate the Effective Area, the Correction Area or the Motion Detect Area will be displayed on VIDEO OUT output screen unless they are set as the factory made default setting. To avoid this, check whether E, C or M is displayed on the menu screen when starting up the unit.

A message "UNLOCKED" will be displayed and flashing if a video not selected in the VIDEO FORMAT is received.

"FAN ERROR" will be displayed and flashing if a fan error occurs, and "POWER ERROR" will be displayed and flashing if there is a power malfunction. In both cases, turn the unit power OFF and contact your FOR-A supplier immediately.

5. Operation

The IVS-700HS is operated using toggle switches, buttons and the menu screen on the front panel. If "LOCK" is displayed on the display panel, turn the **LOCK/OPERATE** toggle switch to "OPERATE", and then make setting changes. The system-related settings can be made in the system menu. To change the parameter of the system menu, enter the system mode by holding down the MODE button for several seconds.

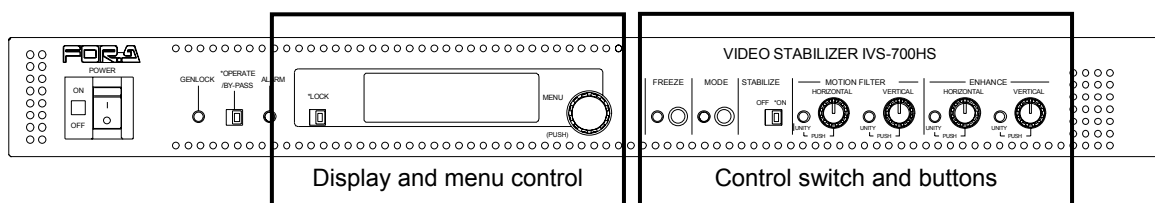

5-1. Menu List

This section provides an explanation of all available IVS-700HS menu settings in order of the menu display. The parameters in the shaded cells are operated by the buttons or the toggle switches on the front panel. See section 5-2-1 "Button Operation" for use of the buttons and the toggle switches and 5-2-2 "Menu Operations" for instructions on operation menu.

5-1-1. Operation Menu

Feature	Description	Factory Setting	Setting Range	Ref.
Stabilize	Switches video shaking correction ON/OFF.	ON	ON/OFF	6-1
Correction Level	Sets the correction level.	5	0 to 15	6-2
Motion Filter	VER	0	0 to 15	6-3
	HOR	0	0 to 15	
Enhance	VER	0	0 to 15	6-4
	HOR	0	0 to 15	
Anti-alias Filter	VER	15	0 to 15	6-5
	HOR	15	0 to 15	
Freeze	Button	OFF	ON/OFF	6-6
	Menu	Odd Only	Frame Freeze, Odd Only, Even Only	
Set Unity	Sets the UNITY value of the Motion Filter and the Enhance.	---	Mot-F(H), Mot-F(V), ENH(H), ENH(V)	5-3-2
Control	Sets the operation mode.	Local	Local, Serial, GPI	7-2
Serial Select	Selects RS-232C or RS-422.	RS-232C	RS-232C, RS-422	7-2-3
Control Lock	Locks the operation button.	OFF	ON/OFF	7-2-2
Software Version (Hardware Version)	Displays software and hardware versions.			

IMPORTANT

The operation button status on the front panel and the menu settings will remain unchanged (except the FREEZE button) when the system is restarted. To restore all parameters to factory default, refer to section 7-3 "Returning to Default."

5-1-2. System Menu

The system menu can be viewed by turning the menu control. To change the system menu settings, enter the system mode by holding down the MODE button until the LED is lit. Press the button again to return to the normal operation. See section 5-2-2 "Menu Operations " for menu settings. To make the operation easier, the Jog/Shuttle feature is available in the Motion Detect Area setting.

NOTE

When switching from the operation menu to the system menu, complete the settings, and then press the MODE button. Do not press the MODE button until the setting has been completed as well as when exiting from the system menu.

When in the System Mode, a rectangle or a masked region that indicate the Effective Area, the Correction Area or the Motion Detect Area will be displayed on VIDEO OUT output screen unless they are set as the factory made default setting. To avoid this, check whether E, C or M is displayed on the menu screen when starting up the unit.

Feature	Description	Factory Settings		Setting Range		Ref.	
Effective Area	Sets effective area.	HD	16:9(+0)	16:9(+0) to 16:9(+7) (8 steps) 4:3(-7) to 4:3(+7) (15 steps)		6-7	
		SD	4:3(+0)	4:3(+0) to 4:3(+7) (8 steps) 16:9(-7) to 16:9(+7) (15 steps)			
				Adjust	Start_H		Varies depending on the video signal.
					Start_V		
		End_H					
		End_V					
Correction Area	Sets the correction area.	0		0 to 15		6-8	
Motion Detect Area	Sets the motion detect area.	Normal		Normal		6-9	
				Adjust	Start_H		Varies depending on the video signal.
					Start_V		
					End_H		
End_V							
Clip Setting	Sets the video clip level.	Super-White	OFF	ON/OFF		6-10	
		Super-Black	OFF	ON/OFF			
		Chroma-Clip	ON	ON/OFF			
Signal Select	Selects the video signal format.	1080/59.94i		1080/59.94i, 1080/60i 1080/50i, 720/60p 720/59.94p, 720/50p 525/60, 625/50		6-11	
Synchronous	Selects the reference signal	Input Lock		Genlock(BB) Genlock(TRI_S) Input Lock		6-12	

5-2. Operation

5-2-1. Button Operation

Stabilize can be switched ON/OFF using the toggle switch on the front panel. Although “Stabilize” is displayed in the menu, it is used only for display. For Motion Filter and the Enhance, turn each button on the front panel. When you turn the button, the setting value will be displayed in the menu. However, “Motion Filter” and “Enhance” menu are used only for display.

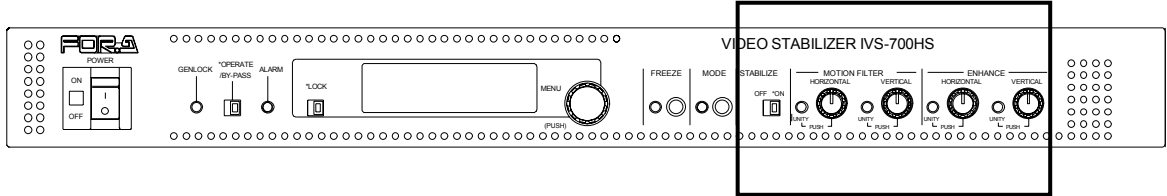

Feature	Description	Ref.
Stabilize	Used to switch video shaking correction ON/OFF.	6-1
Motion Filter	Used to adjust the motion filter for smooth correction.	6-3
Enhance	Used to adjust the edge enhancement.	6-4

Each parameter for the MOTION FILTER and ENHANCE can be set to UNITY (default) with a single press of a button. The UNITY values can also be set by the user. See section 5-3 “UNITY.”

5-2-2. Menu Operations

The procedures for selecting menus and making settings and adjustments are shown below

(1) Turn the menu control on the front panel to select the menu item.

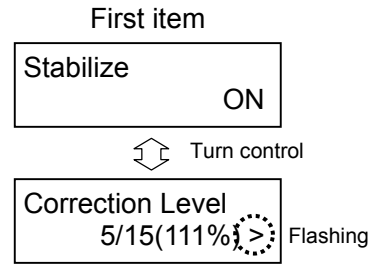
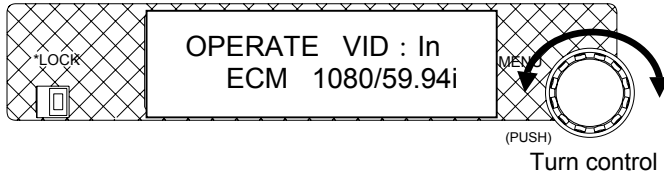

(2) The current setting for the selected item is shown with a flashing ">" mark.

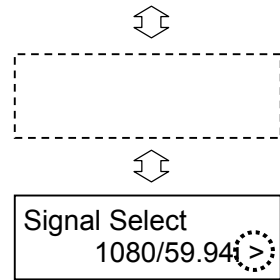
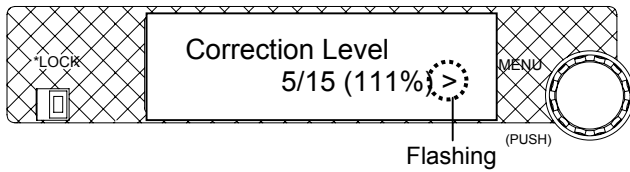

(3) When the control is pressed, the setting item flashes to indicate that the setting can be changed.

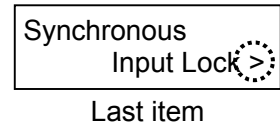
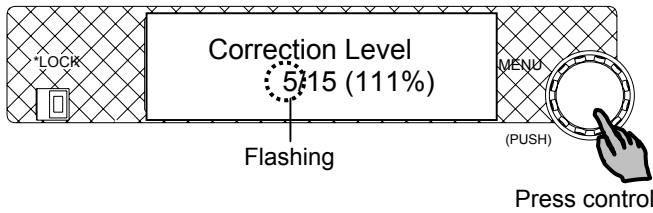

IMPORTANT

When the ">" mark is flashing at the bottom right of the display panel, pressing the control makes the setting item flash so that the setting can be changed.

(4) Turn the control to change the setting for the selected menu item.

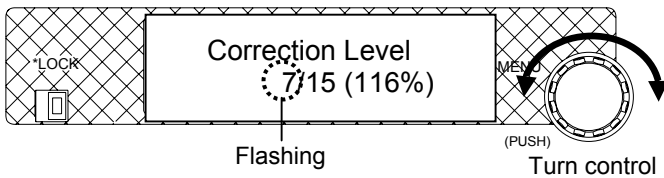

(5) Press the control to apply the current setting.

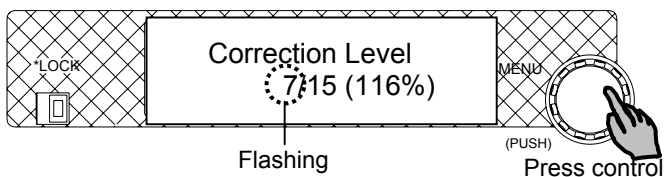

◆ Submenu

The procedure for submenu operation is the same as the procedure for menu operation. To return to the upper menu, select “ -to TOP- ” and press the control. For more detail about submenu operation, see section 5-3-2 “Setting UNITY Values.”

◆ Jog/Shuttle Mode

The Jog Mode and the Shuttle Mode are available whenever “Adjust” is selected in the Mot-Detect (Motion Detect) Area under the system menu,

<Selecting the Shuttle Mode>

The mode selection item will be displayed at the bottom of the parameters in the sub menu.

- 1) Press the menu control when “Jog Mode” is displayed.
- 2) “>” will start flashing.
- 3) Turn the menu control and select the Shuttle Mode.
- 4) “Shuttle Mode” will start flashing.
- 5) Press the menu control to apply the setting

Repeat the same procedure for returning to the Jog Mode.

<Operating in the Shuttle Mode>

- Turning the menu control one step right (left) gradually increases (decreases) the setting value. Turning the control one more step right (left) displays “>>”, and quickly increases (decreases) the setting value. To set the value, press the menu control.
- Four steps of speed are available in the Shuttle Mode and these steps of speed are expressed as the number of the code “>”. The normal speed is represented by the “>” , while the highest speed is represented by the “>>>>”.

5-3. UNITY

Each parameter for the MOTION FILTER and ENHANCE can be set to UNITY (default) with a single press of a button. The UNITY values can also be set by the user. The procedures for setting parameters to UNITY and making UNITY values are described below.

IMPORTANT
To restore all parameters to factory default, refer to section 7-3 "Returning to Default."

5-3-1. Setting Parameters to UNITY

- 1) Press the control once. The unity default setting is applied to the parameter and the UNITY indicator at the left turns on.

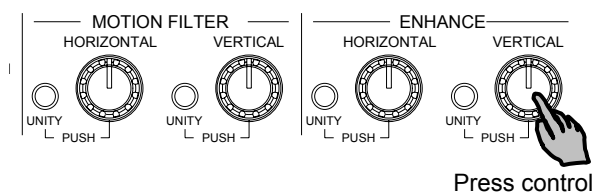

- 2) Press the control again. The UNITY indicator turns off and the parameter is returned to the control set value. You can adjust the value of the parameter again using the control.

5-3-2. Setting UNITY Values



The user can set the desired UNITY values instead of the factory defaults. The setting procedure is as follows.

- (1) Turn the menu control on the front panel to display the "Set Unity" menu.
- (2) After verifying the ">" at the right of the menu is flashing, press the menu control to access the setting stage.
- (3) When the control is pressed, the parameter names appear. Turn the control to select the parameter (see the table below) whose UNITY value you want to.

Abbrev. for Parameters	Description	Factory Settings	Setting Range
Mot-F (H)	Motion Filter (Horizontal)	0	0 to 15
Mot-F (V)	Motion Filter (Vertical)	0	0 to 15
ENH (H)	Enhance (Horizontal)	0	0 to 15
ENH (V)	Enhance (Vertical)	0	0 to 15
Aply Curr Value	Applies the current value to UNITY for all parameters above.	---	---
-to Top-	Returns to the upper menu.	---	---

- (4) When the control is pressed, the setting value flashes to indicate that the setting can be changed. Turn the control to change the value.
- (5) Press the control to apply the current setting.

◆ **Setting logic**

-  Turn to switch between
-  Press to select
-  Flashing

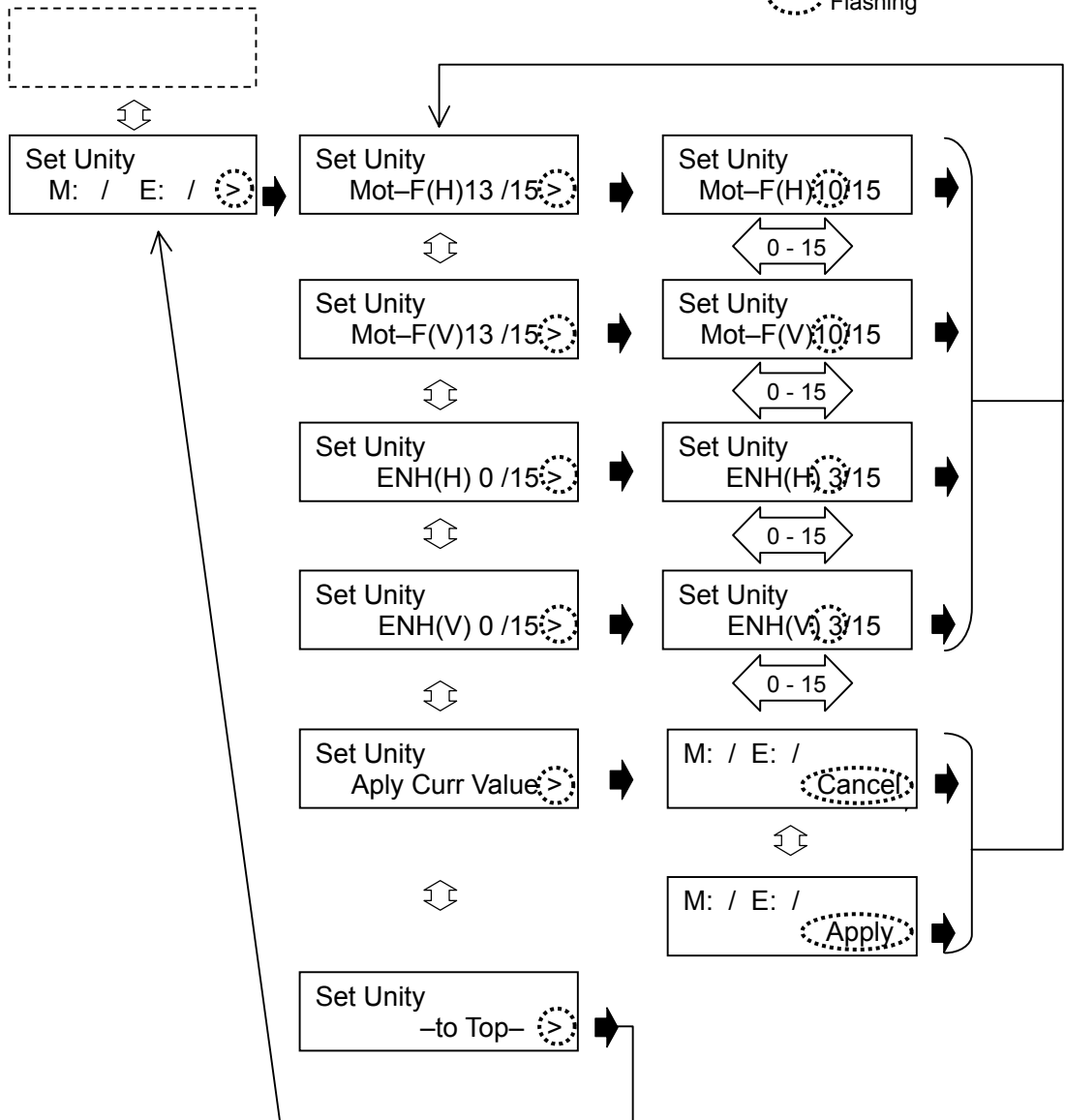

IMPORTANT

The UNITY settings are kept even after the unit is powered off. However, they are returned to the factory default after the unit is initialized.

6. Operation Setting

In this chapter the labels as shown below give you at-a glance reference for how to set parameters.

Button	Menu	System Menu	Menu Display	UNITY Button	JOG/SHUTTLE
--------	------	-------------	--------------	--------------	-------------

6-1. Video Shaking Correction (Stabilize)

Button			Menu Display		
--------	--	--	--------------	--	--

The STABILIZE switch is used to set video shaking correction ON/OFF.

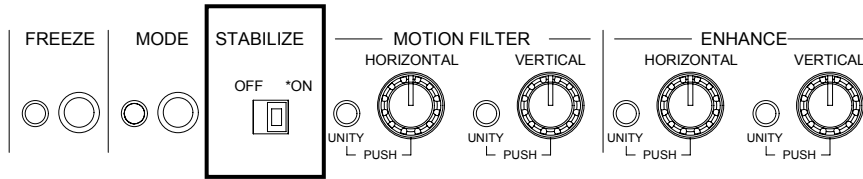

If the switch is set to ON, video shaking is corrected, and images are magnified based on the percentage set in section 6-2 “Correction Level.” If the switch is set to OFF, video shaking is not corrected, and images are magnified based on the percentage set in the menu. The input signals are bypassed and output from VIDEO OUT1 whenever the OPERATE/BY-PASS toggle switch on the front panel is set to BY-PASS regardless of the STABILIZE setting. The STABILIZE setting can be also checked in the “Stabilize” menu of the menu display. Note that the Stabilize menu is used only for display.

6-2. Correction Level

	Menu				
--	------	--	--	--	--

The “Correction Level” determines the correction range. This parameter can be set in the “Correction Level” menu. The image magnification percentage for this level is also displayed. If set higher, larger motions can be corrected, however, the corrected image can cover only a small area. If set lower, larger motions cannot be corrected, however, the corrected image can cover a large area.

Settings less than 4 are effective for small vibrations caused by machines, winds, etc.

Even if set to 0, video stabilization is available if the motions are small.

Settings between 5 to 10 are effective for camera shake, wheel deflections, etc.

Settings more than 10 are effective for high zooming or if an object is very close to the camera.

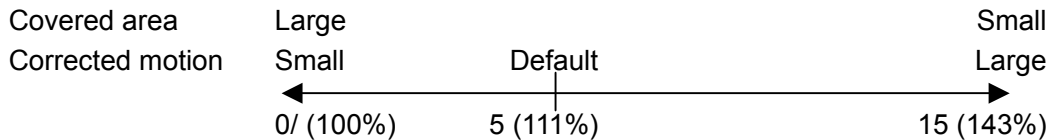

6-3. Motion Filter

Button			Menu Display	UNITY Button	
--------	--	--	--------------	--------------	--

MOTION FILTER determines the filtering level for video stabilization. The level can be set separately for Horizontal and Vertical in the range from 0 to 15. (0 Minimum strength, 15: Maximum strength) using the controls below.

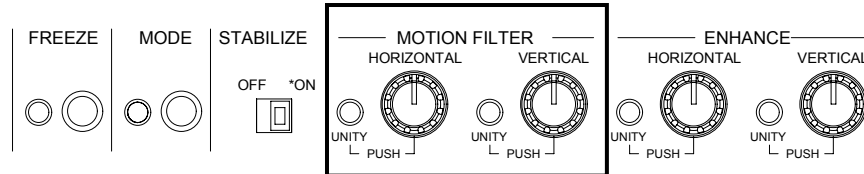

Set higher to use a filter giving priority to video stabilization.
Set lower to use a filter giving priority to smoothness.

Settings between 13 to 15 are effective for fixed point monitoring, such as for stationary cameras. Settings between 0 to 5 are effective for mobile cameras. The MOTION FILTER settings can be also checked in the "Motion Filter" menu of the menu display. Note that the "Motion Filter" menu is only used for display.



NOTE

Each control can be pressed to set the parameter to UNITY (default). The user can set the desired UNITY values instead of the factory defaults. See section 5-3 "UNITY."

6-4. Enhance

Button			Menu Display	UNITY Button	
--------	--	--	--------------	--------------	--

ENHANCE (edge enhancement) uses the image intensity gradient to enhance object boundaries. The enhance level can be adjusted separately for Horizontal and Vertical in the range from 0 to 15.

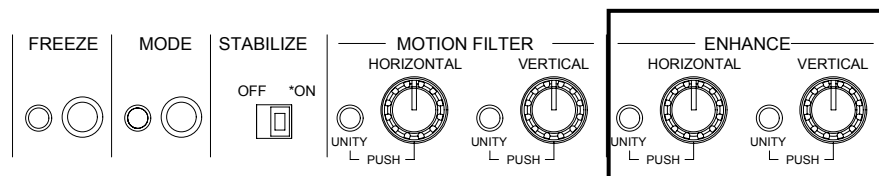

The ENHANCE settings can be also checked in the "Enhance" menu of the menu display. Note that the "Enhance" menu is used only for display.

NOTE

Each control can be pressed to set the parameter to UNITY (default). The user can set the desired UNITY values instead of the factory defaults. See section 5-3 "UNITY."

6-5. Anti-alias Filter

	Menu				
--	-------------	--	--	--	--

“Anti-alias Filter” menu is used to reduce the jagged diagonal lines when enlarging the images. This parameter can be set in the range from 0 to 15 levels. If set to 0, no anti-alias is applied. In contrast, setting to 15 applies the maximum strength of anti-alias.

6-6. Freeze

Button	Menu				
---------------	-------------	--	--	--	--

The FREEZE button switches freeze mode ON/OFF.

◆ Setting Video Freeze

1) Press button to set freeze mode ON (indicator light on).

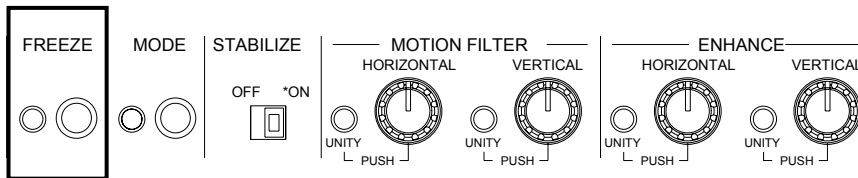

2) Even or odd field freeze can be also selected in the “Freeze Mode” menu (See below).

Freeze Mode Setting	Description
Frame Freeze	Freezes a frame
Odd Only	Freezes an odd field (Default)
Even Only	Freezes an even field

Press button again to set freeze mode OFF (indicator light off).

6-7. Effective Area

	System Menu	Menu Display		
--	--------------------	---------------------	--	--

The “Effective Area” determines the region where the image is displayed. The “Effective Area” setting is useful to reduce edge noise, especially for the blackish noise caused by video conversion between 4:3 and 16:9 images.



Example1:
16:9 Side Panel



Example2:
4:3 Letter Box

◆ **Setting the Effective Area**

- 1) Press and hold down the MODE button for several seconds until the LED is lit to enter the system mode.
- 2) In the system mode, select the Effective Area menu.
- 3) While monitoring the VIDEO OUT image, set the Effective Area. This setting affects both the width and height at the same time, at the same ratio, so the video keeps the same dimensions. However selecting 4:3 for 16:9 images or 16:9 for 4:3 images automatically cuts the height or the width of the image at first. And then setting the number value in the parentheses adjusts both the width and the height at the same time.

Setting Range	
HD	16:9(+0) to 16:9(+7) (8 steps) 4:3(-7) to 4:3(+7) (15 steps)
SD	4:3(+0) to 4:3(+7) (8 steps) 16:9(-7) to 16:9(+7) (15 steps)

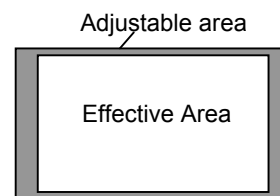

- 4) When “Adjust” is selected, following four parameters are appeared. Use these four parameters to finely adjust the Effective Area.

When operating in the HD mode:

Parameter	Setting Range
Start_H	16:9(+0)to16:9(+7) (8 steps) 4:3(-7)to4:3(+7) (15 steps)
Start_V	Normal(+0) to Normal(+7) (8 steps)
End_H	16:9(+0)to16:9(+7) (8 steps) 4:3(-7)to4:3(+7) (15 steps)
End_V	Normal(+0) to Normal(+7) (8 steps)

The aspect ratio is represented by 16:9 or 4:3.
The number in the parentheses represents value for adjustment on a 2-pixel resolution.

(Start_H, Start_V)
(4:3 (+7), Normal(+7))

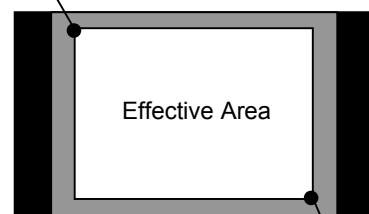

Setting Example 1:
16:9 Side Panel

(End_H, End_V)
(4:3(+7), Normal(+7))

When operating in the SD mode:

Parameter	Setting Range
Start_H	Normal(+0) to Normal(+7) (8 steps)
Start_V	4:3(+0)to4:3(+7) (8steps) 16:9(-7)to16:9(+7) (15steps)
End_H	Normal(+0) to Normal(+7) (8 steps)
End_V	4:3(+0) to 4:3(+7) (8 steps) 16:9(-7) to 16:9(+7) (15 steps)

The aspect ratio is represented by 16:9 or 4:3.
The number in the parentheses represents value for adjustment on a 2-pixel resolution.

(Start_H, Start_V)
(Normal (0), 16:9(-2))

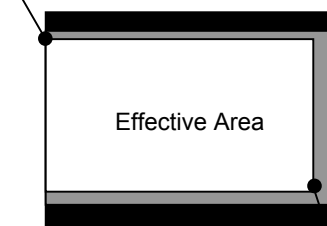

Setting Example 2:
4:3 Letter Box

(End_H, End_V)
(Normal(+7), 16:9(+5))

IMPORTANT

While setting the Effective Area, a rectangle or a masked region that indicates the Effective Area will be displayed on VIDEO OUT output screen unless it is set as the factory made default setting. To avoid this, check whether “E” is displayed on the menu screen when starting up the unit. After the setting has been completed, the rectangle region will disappear. Note that setting the “Effective Area” lets the “Correction Area and “Motion Detect Area” return to factory default settings.

6-8. Correction Area

		System Menu	Menu Display		
--	--	-------------	--------------	--	--

The “Correction Area” determines the region to be corrected in the image. The Correction Area can be set in the range from 0/15 to 15/15.

When set to “0/15” (i.e., The Correction Area equals the Effective Area.):

If the Correction Area exceeds the correction limit because the images are magnified based on the percentage set in the “Correction Level” (See section 6-2), an adequate stabilization cannot be made although the images will not be cut off. To correct the images, set the “Correction Level” higher.

When set to “1/15” to “15/15”:

Although a part of the images may be cut off after the correction, the images are corrected properly even when the Correction Area exceeds the correction limit where the correction area is set to “0/15”.

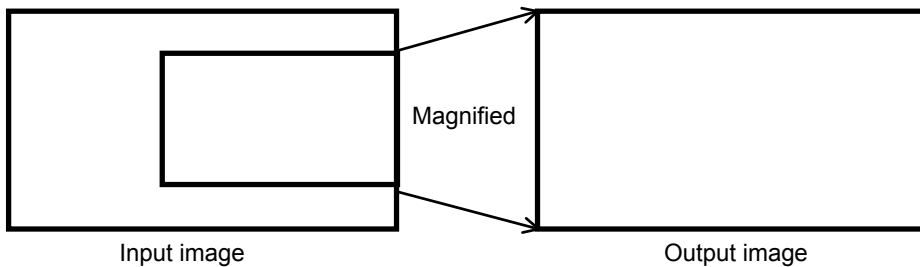

When set to “0” (same as the Effective Area):

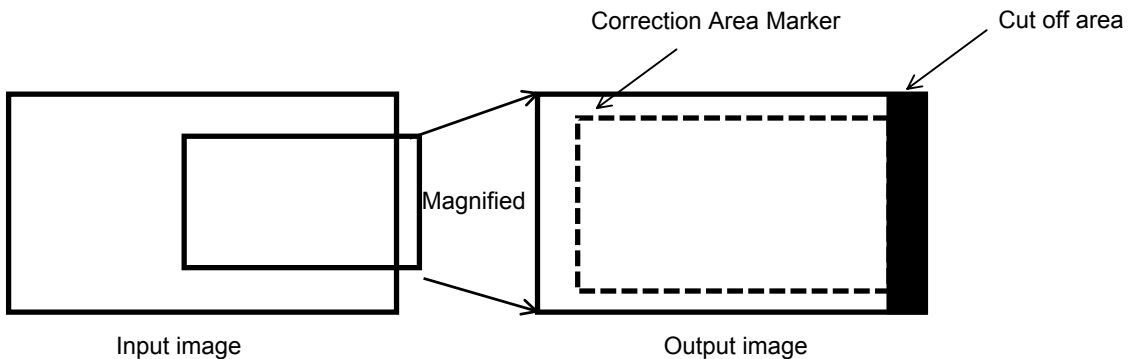

When set to “1” to “15”:

◆ Setting the Correction Area

- 1) Press and hold down the MODE button for several seconds until the LED is lit to enter the system mode.
- 2) In the system mode, select the Correction Area menu.
- 3) While monitoring the VIDEO OUT image, set the Correction Area.

6-9. Motion Detect Area

		System Menu	Menu Display		JOG/SHUTTLE
--	--	-------------	--------------	--	-------------

The “Motion Detect Area” determines the region where the Video Shaking Correction (Stabilize) is applied.

◆ Setting the Correction Area

- 1) Press and hold down the MODE button for several seconds until the LED is lit to enter the system mode.
- 2) In the system mode, select the Mot-Detect Area menu.
- 3) While monitoring the VIDEO OUT image, set the Mot-Detect Area.

When “Adjust” setting is selected, the Motion Detect Area can be set by the parameter of the upper left corner point (Start-H, Start-V) and the lower right corner point (End-H, End-V) of the rectangular area (See the figure below).

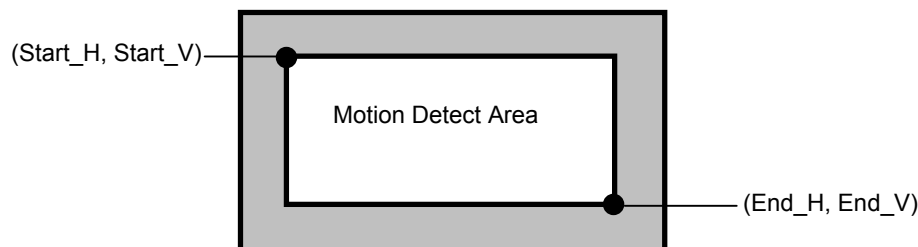

Setting Range of the Motion Detect Area (1080/59.94i, 1080/60i, 1080/50i)

Start_H	48 to 784	Start_V	27 to 385
End_H	176 to 912	End_V	155 to 513

Setting Range of the Motion Detect Area (720/60p, 720/59.94p, 720/50p)

Start_H	32 to 480	Start_V	36 to 556
End_H	160 to 608	End_V	164 to 684

Setting Range of the Motion Detect Area (525/60)

Start_H	18 to 310	Start_V	12 to 197
End_H	50 to 342	End_V	44 to 229

Setting Range of the Motion Detect Area (625/50)

Start_H	18 to 310	Start_V	14 to 239
End_H	50 to 342	End_V	46 to 271

IMPORTANT

The “Motion Detect Area” cannot be set less than 128(H) x 128 (V) for HD, or 32(H) x 32 (V) for SD.

The value of the End-H and the End-V cannot be set smaller than the value of the Start-H and the Start-V. Note that the system will produce the mask signal to indicate the Motion Detect Area while Motion Detect Area setting. After the setting has been completed, the mask signal will disappear.

6-10. Video Clip Level (Clip Setting)

		System Menu	Menu Display		
--	--	--------------------	---------------------	--	--

The "Clip Setting" determines higher and lower levels of luminance and chrominance for video output signal. To go to the "Clip Setting" menu, enter the system mode by holding down the Mode button until the indicator lights.

Clip Setting	Setting	Description
Super-White	ON	Sets higher luminance level to 1019 (approx.109%).
	OFF (default)	Sets higher luminance level to 1940 (100%).
Super-Black	ON	Sets lower luminance level to 4 (approx.-7%).
	OFF (default)	Sets lower luminance level to 64 (0%).
Chroma-Clip	ON (default)	Sets higher/lower chrominance levels to 960 (+100%) / 64 (-100%)
	OFF	Sets higher/lower chrominance levels to 1019 (approx. +113%) / 4 (approx. -113%)

* The values above are 10-bit coded samples.

6-11. Video Signal Standard (Signal Select)

		System Menu	Menu Display		
--	--	--------------------	---------------------	--	--

The "Signal Select" menu is for selecting the input video signal format. To go to the "Signal Select" menu, enter the system mode by holding down the Mode button until the indicator lights.

Video Signal Format	1080/59.94i, 1080/60i 1080/50i, 720/60p 720/59.94p, 720/50p 525/60, 625/50
---------------------	---

6-12. Sync Mode (Synchronous)

		System Menu	Menu Display		
--	--	--------------------	---------------------	--	--

The “Synchronous” is for selecting the sync signal format used in the IVS-700HS. To go to the “Synchronous” menu, enter the system mode by holding down the Mode button until the indicator lights.

Synchronous Setting	Description
Genlock (BB)	Uses the external reference signal (Black Burst) input from the GENLOCK connector on the rear panel.
Genlock (TRI_S)	Uses the external reference signal (Tri Level sync) input from the GENLOCK connector on the rear panel.
Input Lock	Uses the input video signal as a reference.

IMPORTANT
The genlock input enables to align the horizontal phase of output video. (Phase-lock range: $\pm 1/2H$) The vertical phase lock function is not implemented. So input the reference signal of the same phase as SDI inputs.

The items selected in the Signal Select menu and Synchronous menu are related each other. Below is a chart of valid reference video/ routed video combinations for the IVS-700HS. It is unable to select the invalid combinations.

	1080/ 59.94i	1080/ 60i	1080/ 50i	720/ 60p	720/ 59.94p	720/ 50p	525/60	625/50
BB	○	—	○	—	○	○	○	○
TRI_S	○	○	○	—	○	—	—	—
Input Lock	○	○	○	○	○	○	○	○

7. The Other Settings

7-1. OPERATE / BY-PASS

You can use the toggle switch on the front panel to select the output signals to be corrected.

IMPORTANT

The OPERATE/BY-PASS toggle switch is disabled during remote control of the unit.

7-1-1. OPERATE

The OPERATE / BY-PASS toggle switch should go to lit and corrected video signals are output.

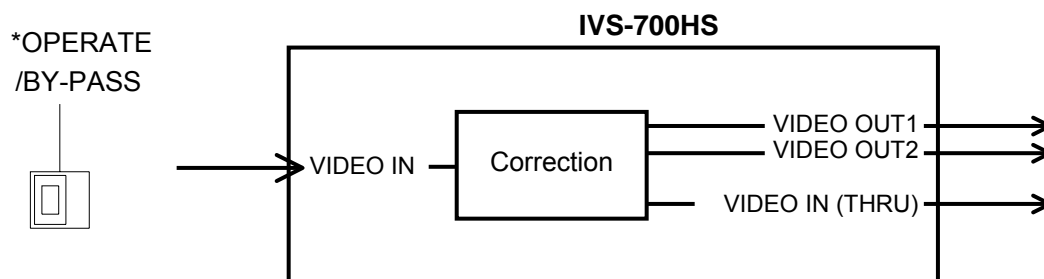

NOTE

If Stabilize is set to OFF in the menu, the signals are not corrected, but the magnification percentage in the Correction Level setting is still enabled.

7-1-2. BY-PASS

The OPERATE / BY-PASS toggle switch should go to unlit and the input signal is by-passed uncorrected.

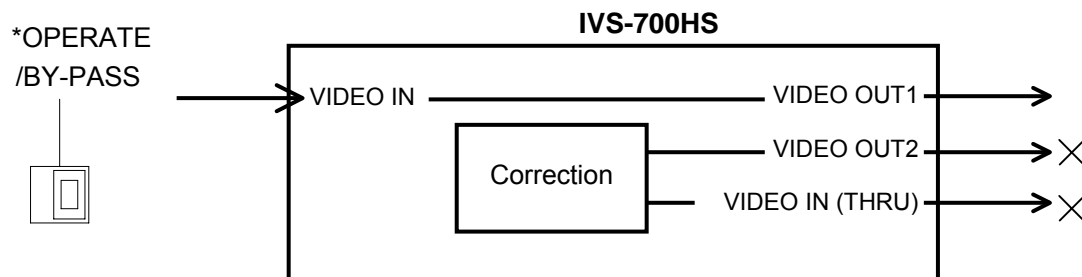

7-2. OPERATION MODE

The operational mode status is displayed at the top of the menu display as shown in the table below.

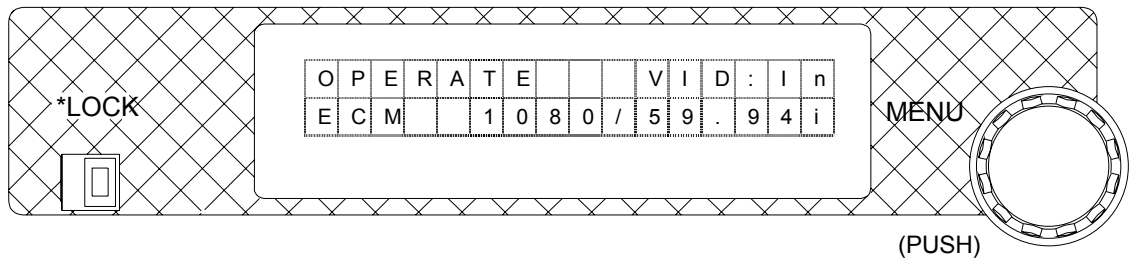

Mode Display	Description
OPERATE	Operates in local mode. All process button and menu controls on the front panel are enabled.
-LOCK-	Operates in local mode. However, all menu operations are locked and disabled.
-Serial mode-	Operates in serial mode with RS-232C or RS-422. All process button and menu controls except setting display and "Control" menu setting on the front panel are disabled.
-GPI mode-	Operates in GPI mode. All process button and menu controls except setting display and "Control" menu setting on the front panel are disabled.

7-2-1. Menu Lock

The menu lock switch on the front panel enables / disables the use of the menu control. If the switch is set to left, the menu control is locked.

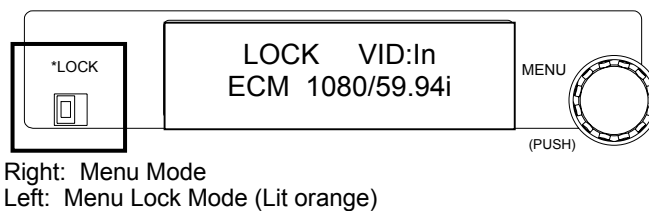

7-2-2. Button Lock

All process control buttons indicated in the figure below can be also locked. This can be done by changing the "Control Lock" menu to ON.

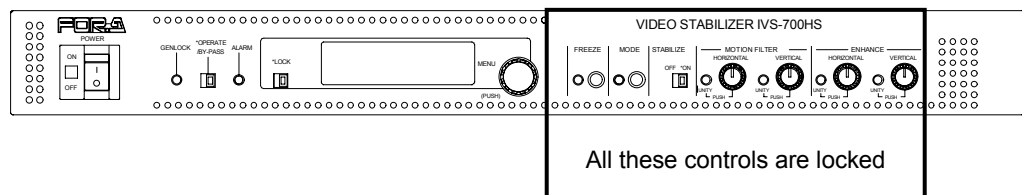

7-2-3. Serial and GPI Mode Setting

If you want to control the unit remotely, make an appropriate connection and change the "Control" menu from "Local" to "Serial" or "GPI." If you select a "Serial" connection, then select the RS-232C or RS-422 in the "Serial Select" menu. See section 8 "Remote Control."

7-3. Returning to Default

If you need to return all settings to the factory made default settings, this can be done by turning power ON at the IVS-700HS while pressing and holding down the menu control. Refer to section. 5-1 "Menu List" for factory default settings.

IMPORTANT

Note that if you return all settings to default, user made UNITY settings are also returned to the factory settings.
--

8. Remote Control

To control the unit remotely, change the menu setting to the “Remote Control.” See section 7-2-3 “Serial and GPI Mode Setting.”

8-1. RS-232C/422 Connector

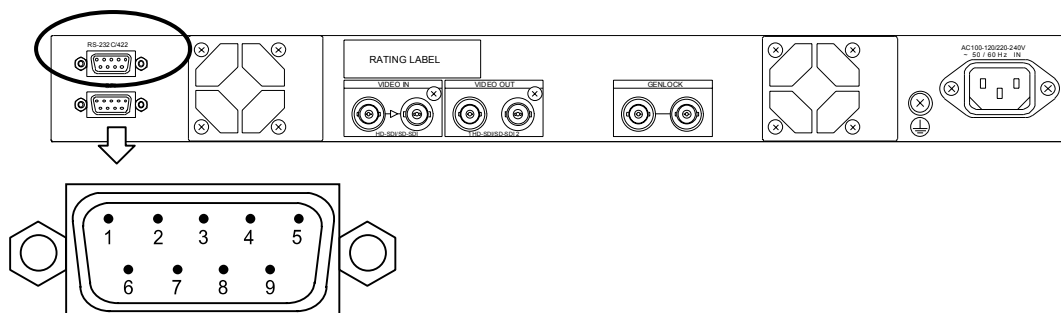

8-1-1. If RS-232C Used

◆ Communication parameters

Baud rate	38400 [bps]
Data length	8 [bit]
Stop bit	1 [bit]
Parity	None
X parameter (flow control)	None
Send text interval	More than 0 [ms]
Command interval	More than 10 [ms]

◆ RS-232C Pin Assignment Table (9-pin D-sub male)

Pin No.	Signal	Description
1	OPEN	N/C
2	RxD	Receive data
3	TxD	Transmit data
4	OPEN	N/C
5	GND	Signal ground
6	OPEN	N/C
7	RTS	Request to send. Uses internal connection to CTS.
8	CTS	Clear to send. Uses internal connection to RTS.
9	OPEN	N/C

IMPORTANT

If connecting to a computer or other device, use a RS-232C cross cable with a length of 10 m or less.

8-1-2. If RS-422 Used

◆ Communication parameters

Baud rate	38400 [bps]
Data length	8 [bit]
Stop bit	1 [bit]
Parity	None
X parameter (flow control)	None
Send text interval	More than 0 [ms]
Command interval	More than 10 [ms]

◆ RS-422 Pin Assignment Table (9-pin D-sub male)

Pin No.	Signal	Signal Details
1	GND	Ground
2	Transmit A (T-)	
3	Receive B (R+)	
4	Open	
5	Open	
6	Open	
7	Transmit B (T+)	
8	Receive A (R-)	
9	GND	Ground

IMPORTANT

The connection with the normal RS-422 interface has a different pin arrangement, and so a special cable is used that matches this pin arrangement. Be sure that the connection distance does not exceed 100 m.

8-1-3. Communication Protocol

Setting value: **Command [Space] Setting Value [Enter]**
 The value is set to the parameter invoked by the command

Getting value: **Command [Enter]**
 The parameter value invoked by the command is displayed.

Input text: **ASCII**

No echo back of the input text is performed from the IVS-700HS.
 The communication systems shown above are performed using the input keys shown in the table below.

Input Keys

Command	Uppercase letter from A to Z	—
[Space]	Space (20H)	Delimiter for command and data
Setting value	Hexadecimal expression using 1 to 9 and A to F	—
[Enter]	CR (0DH)	Single-line delimiter
	LF (0AH) *Can be omitted	

The menu setting values are displayed after entering Command [Space] Command Data [Enter]. (See examples 1 and 2.)

Example 1: When STABI [Space] 01 [Enter] is entered from the terminal. (Input system 1)

Input: STABI 01[CR+LF]
 ASCII code: [53H][54H][41H][42H][49H][20H][30H][31H][0DH][0AH]
 Return: Write: 01

Example 2: When STABI [Enter] is entered from the terminal. (Input system 2)

Input: STABI [CR+LF]
 ASCII code: [53H][54H][41H][42H][49H][0DH][0AH]
 Return: Read: 01

Example 3:

Input: STABI 0123[CR+LF]
 Return: Write : 01 (Only 01 is valid.)

The input value is displayed as a 2-digit hexadecimal value using 0 to 9 and A to F.
 If a value with more than two digits is entered, the first two digits from the top are used.

8-1-4. Command List

Table of Comparing between Local and Serial Control Commands

Local Control commands		Serial control commands	Input value (Hex)	
By-pass / Operate	Switch	BYPAS	00	OPERATE
			01	BY-PASS
Lock	Switch	—	—	—
Stabilize	Switch	STABI	00	ON
			01	OFF
Correction Level	Menu	CORRECT	00 to 0F	
Motion Filter	HORIZONTAL	Volume	MOTH	00 to 0F
	VERTICAL		MOTV	00 to 0F
Enhance	HORIZONTAL	Volume	ENHH	00 to 0F
	VERTICAL		ENHV	00 to 0F
Anti-alias Filter	HORIZONTAL	Menu	AAFH	00 to 0F
	VERTICAL		AAFV	00 to 0F
Freeze	Button	FRZS	00	OFF
			01	ON
Freeze Mode	Menu	FRZM	00	Odd
			01	Even
			02	Frame
Set Unity	Menu	—	—	
Control	Menu	CTRL (*1)	00	Local
			01	Serial
			02	GPI
Serial Select	Menu	—	—	
Control Lock	Menu	—	—	
Software Version (Hardware Version)	Menu	VERSION	Display only	
Mode	Button	MODE (*2)	00	OFF
			01	ON

The parameters in the shaded cells are operated by the buttons or the toggle switches on the front panel.

(*1) CTRL command

If CTRL is not set to "01", any command other than the CTRL command is rejected, and an error code is returned. However, the CTRL command can change the control setting from Serial even if the control is not at Serial.

During serial remote control, control operations on the front panel only allow viewing of the setting values of the menus. (However, the setting values for the Control menu can be changed.) The OPERATE/BY-PASS toggle switch is disabled. (The LED of the OPERATE/BY-PASS toggle switch turns on and off according to the serial remote setting.)

(*2) MODE command

If MODE is set to "00", the system menu parameters cannot be changed. Before changing the system menu parameters, set MODE to "01."

Local Control commands			Serial control commands	Input value (Hex)		
Effective Area	—		EAREA	00	Displays corrected image	
	—			01	Displays Effective Area	
	4:3 HD		EFMOD	00	HD4:3 SD16:9	
	16:9 SD			01	Adjust	
	Adjust	Start_H	System menu	FRAME	00 to 07	16:9 (8 steps)
					08 to 16	4:3 (15 steps)
		Start_V		ESTRH	00 to 16	HD
					00 to 07	SD
		End_H		ESTRV	00 to 07	HD
					00 to 16	SD
	End_V	EENDH		00 to 16	HD	
				00 to 07	SD	
		EENDV		00 to 07	HD	
				00 to 16	SD	
Correction Area		System menu		CORA	00 to 0F	
Motion Detect Area	—			MAREA	00	Displays corrected image
	—		01		Displays Motion Detect Area	
	Normal		MDMOD	00	HD4:3 SD16:9	
				01	Adjust	
	Adjust	Start_H	System menu	—		
				Start_V	MSTRH	0030~0310 (1080)
						0020~01E0 (720)
						0012~0136 (525/60)
		0012~0136 (625/50)				
		End_H		MSTRV	001B~0181 (1080)	
					0024~022C (720)	
					000C~00C5 (525/60)	
	000E~00EF (625/50)					
	End_V	MENDH		00B0~0390 (1080)		
				00A0~0260 (720)		
				0032~0156 (525/60)		
0032~0156 (625/50)						
		MENDV		009B~0201 (1080)		
				00A4~02AC (720)		
				002C~00E5 (525/60)		
			002E to 010F (625/50)			
Clip Setting	Super-White	System menu	CSWH	00	OFF	
				01	ON	
	Super-Black		CSBL	00	OFF	
				01	ON	
Chroma-Clip	CSCH	00	OFF			
		01	ON			

(Continued to next page.)

Local Control commands		Serial control commands	Input value (Hex)	
Signal Select	System menu	INSEL	00	525/60
			01	625/50
			02	1080/60i
			03	1080/59.94i
			04	1080/50i
			05	720/60p
			06	720/59.94p
			07	720/50p
Synchronous	System menu	SYNC	00	Input Lock
			01	Genlock (BB)
			02	Genlock (TRI_S)

8-1-5. Error Message

Error messages are displayed in the following cases.

- Command or data could not be received correctly.
- Commands were not executed in the correct mode.

The error message displays the received character string and the error code. Refer to the table below for descriptions of the error codes. Note that the command is cancelled if the received data is determined to be an error. Therefore, the command must be entered again.

Error Codes

ERROR CODE	Description
00	The input code does not match section 8-1-4 "Command list."
01	Characters other than 0 to 9 or A to F in hexadecimal expressions were entered for the setting value.
02	A value that exceeds the setting range was entered.
04	CTRL was not set to "01", and a command other than the CTRL command was entered.
05	The parameter is protected by the MODE command. (Effective Area, Mot-Detect Area, Corrective Area, Input Select, Synchronous)
06	The selected sync signal format is not supported by the selected video format.

Example 1:

Input: CTRL 05[CR+LF]

Return: ERROR : 02

8-2. GPI Connector

The pin arrangement for the GPI connector is shown below. This arrangement cannot be changed.

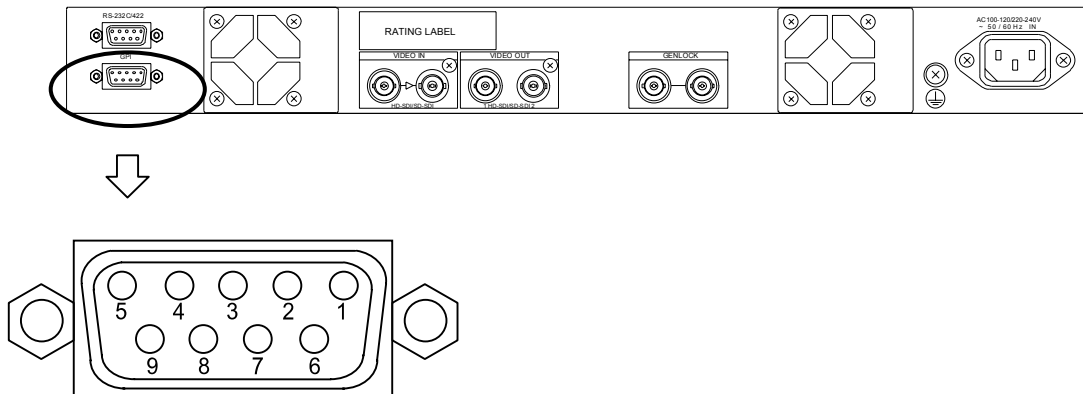

◆ GPI Control Pin Assignment Table (9-pin D-sub female)

Pin No.	Signal Details	I/O	Function	High	Low
1	VCC		+5V		
2	OPERATE / BY-PASS	Output	See sec. 7-1.	BY-PASS	OPERATE
3	VIDEO IN	Output	Input video/None	None	Input video
4	FAN ALARM	Output	—	No fault	Fault occurred
5	Stabilize	Output	See sec.6-1.	OFF	ON
6	OPERATE / BY-PASS	Input	See sec. 7-1.	OPERATE	BY-PASS
7	Stabilize	Input	See sec. 6-1.	ON	OFF
8	Not Used	Input	—		
9	GND		Ground		

8-2-1. GPI Terminal Equivalent Circuit

a) Example of connection with GPI output circuit

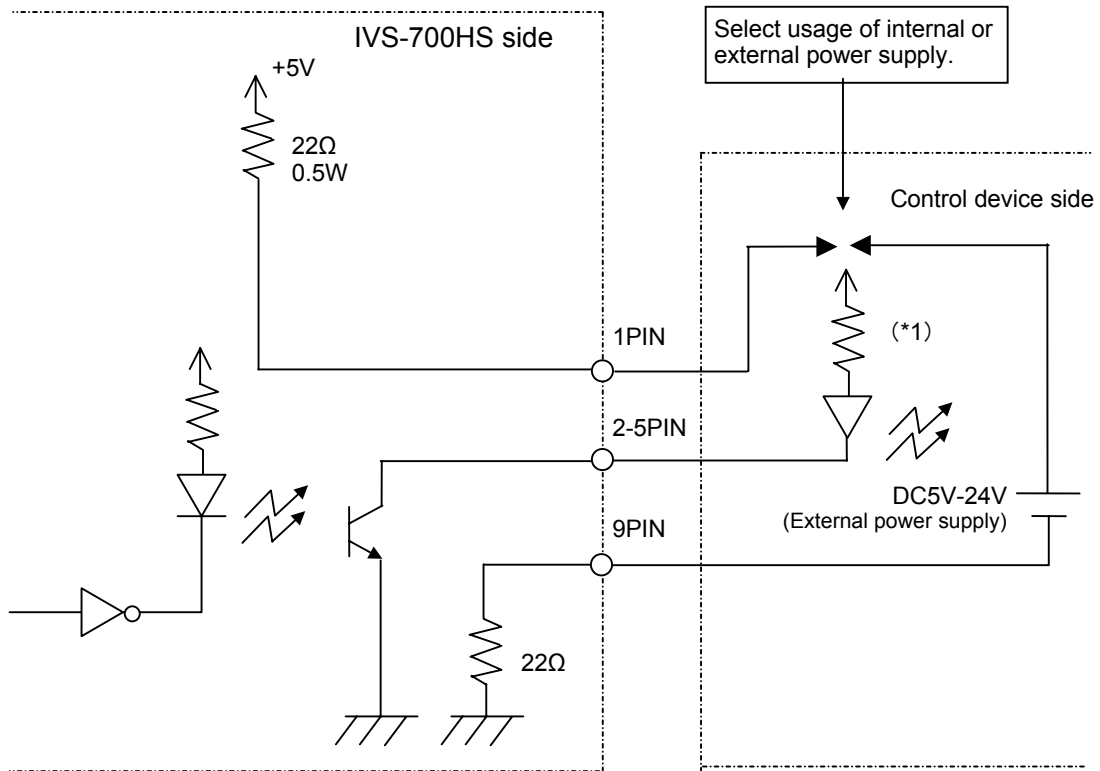

*1) Use a protective resistance at the proper value according to the internal/external supply voltage and LED characteristics.

b) Example of connection with GPI input circuit

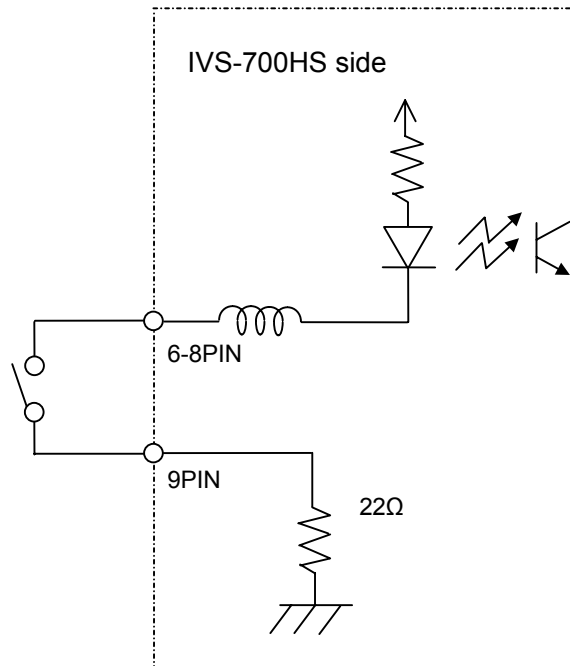

9. If Problems Occur

If any of the following problems occur during operation of your IVS-700HS, proceed as indicated below to see if problem can be corrected before assuming a unit malfunction has occurred.

Problem	Check	Action
Cannot control at front panel	“Control Lock” menu setting	Verify the “Control Lock” set to OFF. See section 7-2-2.
	Unity indicator	Verify the Unity indicator light OFF. See section 5-3-1.
	Operation Mode display at the panel and “Control” menu setting	Verify the “Control” menu set to “LOCAL.” See section 7-2.
Cannot use menu control	Operation Mode display at the panel and menu lock switch setting	Verify the menu lock switch set to right. See section 7-2-1.
Input video signal not bypassed when set to BY-PASS	VIDEO OUT connectors	Verify cable is connected to VIDEO OUT1 connector. (VIDEO OUT2 and MONOTOR OUT never output bypass video) See section 2-2.
Freeze operation not set when FREEZE button pressed	“Control Lock” menu	Verify “Control Lock” set to OFF. See section 7-2-2.
	OPERATE/BY-PASS switch	Verify OPERATE/BY-PASS set to “OPERATE.” See section 7-1-2.

10. Specifications & Dimensions

10-1. Unit Specifications

Standard	1080/59.94i, 1080/60i, 1080/50i, 720/59.94p, 720/60p, 720/50p, 525/60, 625/50 (Select from the menu)				
Signal Processing	4: 2: 2 component				
Sampling Frequency	<table border="0"> <tr> <td>HD SDI</td> <td>Y : 74.25/1.001MHz, 74.25MHz C : 37.125/1.001MHz, 37.125MHz</td> </tr> <tr> <td>SD SDI</td> <td>Y: 13.5 MHz, C: 6.75 MHz</td> </tr> </table>	HD SDI	Y : 74.25/1.001MHz, 74.25MHz C : 37.125/1.001MHz, 37.125MHz	SD SDI	Y: 13.5 MHz, C: 6.75 MHz
HD SDI	Y : 74.25/1.001MHz, 74.25MHz C : 37.125/1.001MHz, 37.125MHz				
SD SDI	Y: 13.5 MHz, C: 6.75 MHz				
Quantization	10-bit				
Video Input	Serial digital component: HD SDI 1.485/1.001Gbps, 1.485Gbps or SD SDI 270Mbps 1 ea., BNC with active thru, 75 ohm				
Video Outputs	Serial digital component: HD SDI 1.485/1.001Gbps, 1.485Gbps or SD SDI 270Mbps 2 ea., BNC, 75 ohm				
Genlock Input	Tri-level Sync $\pm 0.3Vp-p$ or Black Burst 0.429Vp-p (525/60), 0.450Vp-p (625/50) 1 ea., BNC, 75ohm (termination required) or loophru Input phase-lock range: $\pm 1/2H$ against genlock input				
Output Image Size	1920 \times 1080 pixels (1080/59.94i, 1080/60i, 1080/50i), 1280 \times 720 pixels (720/59.94p, 720/60p, 720/50p), 720 \times 486 pixels(525/60), 720 \times 576 pixels (625/50) Image size varies according to the input image size and Correction Level setting in the menu.				
Total Delay	2 frames (without frame synchronizer)				
Correction Function	Correction range: maximum 40 percentage for both vertical and horizontal				
Frequency Response	<table border="0"> <tr> <td>1Hz to 59.94/2Hz (1080/59.94i, 720/59.94p, 525/60)</td> </tr> <tr> <td>1Hz to 60/2Hz (1080/60i, 720/60p)</td> </tr> <tr> <td>1Hz to 50/2Hz (1080/50i, 720/50p, 625/60) for both vertical and horizontal (theoretical values)</td> </tr> </table>	1Hz to 59.94/2Hz (1080/59.94i, 720/59.94p, 525/60)	1Hz to 60/2Hz (1080/60i, 720/60p)	1Hz to 50/2Hz (1080/50i, 720/50p, 625/60) for both vertical and horizontal (theoretical values)	
1Hz to 59.94/2Hz (1080/59.94i, 720/59.94p, 525/60)					
1Hz to 60/2Hz (1080/60i, 720/60p)					
1Hz to 50/2Hz (1080/50i, 720/50p, 625/60) for both vertical and horizontal (theoretical values)					
Motion Type	Vertical, horizontal, and diagonal (two-dimensional)				
Interfaces					
RS-232C/422	9-pin D-sub, 1ea. (male)				
GPI	9-pin D-sub, 1ea. (female)				
	TTL negative logic level or make contact (max. 5V to 24VDC 40mA)				
Temperature	0–40 °C				
Humidity	30%–90% (no condensation)				
Power	100 VAC–120 VAC or 220 VAC–240 VAC $\pm 10\%$, 50 Hz/60 Hz				
Consumption	68VA (48W) at 100VAC 67VA (48W) at 240VAC				
Dimensions	424 (W) \times 350 (D) \times 44 (H) mm EIA 1U				
Weight	7.0 kg				

10-2. External Dimensions

(All dimensions in mm)

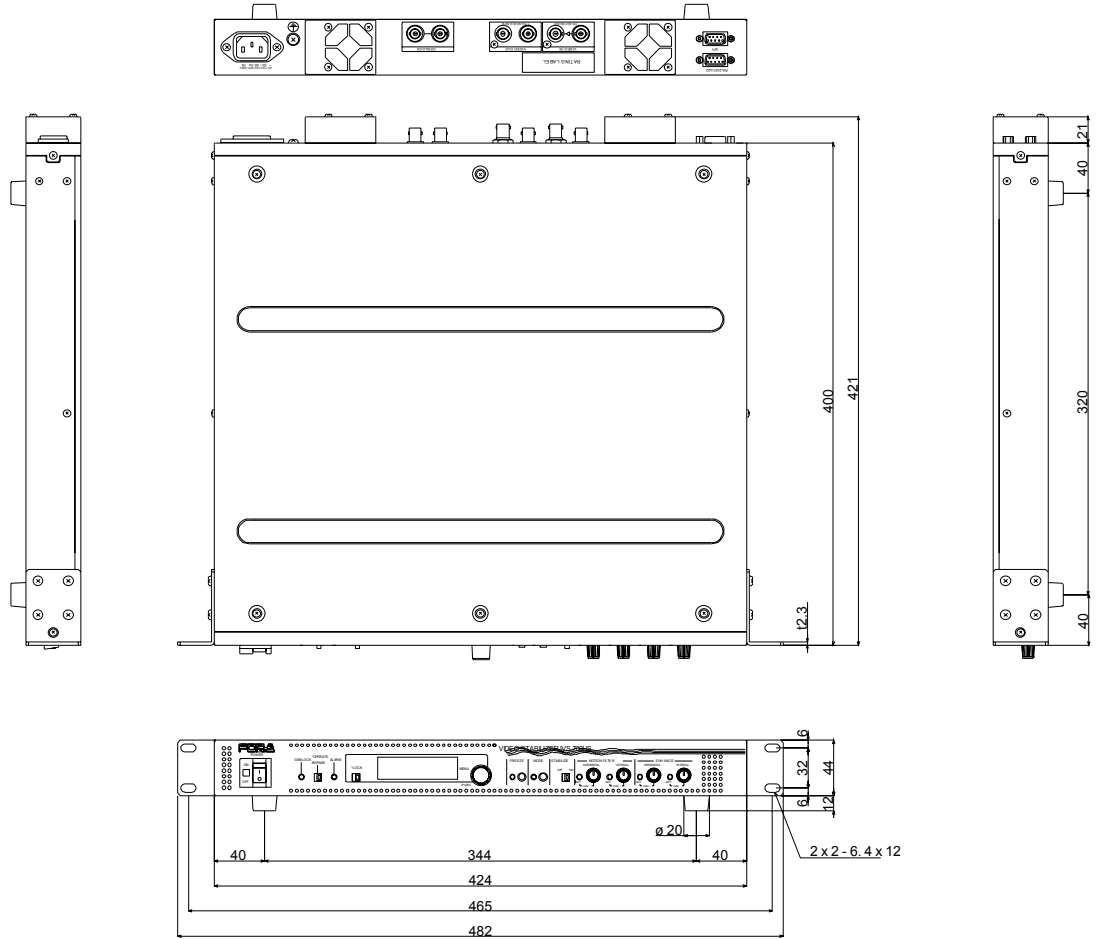

Warning

This equipment has been tested and found to comply with the limits for a Class A digital device, pursuant to Part 15 of FCC Rules. These limits are designed to provide reasonable protection against harmful interference when the equipment is operated in a commercial environment. This equipment generates, uses, and can radiate radio frequency energy and, if not installed and used in accordance with the instruction manual, may cause harmful interference to radio communications. Operation of this equipment in a residential area is likely to cause harmful interference, in which case the user will be required to correct the interference at his own expense.



FOR-A COMPANY LIMITED

Head Office : 3-8-1 Ebisu, Shibuya-ku, Tokyo 150-0013, Japan
Overseas Division Phone: +81 (0)3-3446-3936, Fax: +81 (0)3-3446-1470
Japan Branch Offices : Osaka/Okinawa/Fukuoka/Hiroshima/Nagoya/Sendai/Sapporo
R&D/Production : Sakura Center/Sapporo Center

FOR-A America Corporate Office

11125 Knott Ave., Suite #A, Cypress, CA 90630, USA
Phone: +1 714-894-3311 Fax: +1 714-894-5399

FOR-A America East Coast Office

Two Executive Drive, Suite 670, Fort Lee Executive Park, Fort Lee NJ 07024, USA
Phone: +1 (201) 944-1120 Fax : +1 (201) 944-1132

FOR-A America Distribution & Service Center

2400 N.E. Waldo Road, Gainesville, FL 32609, USA
Phone: +1 352-371-1505 Fax: +1 352-378-5320

FOR-A Corporation of Canada

346A Queen Street West, Toronto, Ontario M5V 2A2, Canada
Phone: +1 416-977-0343 Fax: +1 416-977-0657

FOR-A Latin America & the Caribbean

5200 Blue lagoon Drive,
Suite 760, Miami, FL 33126, USA
Phone: +1-305-931-1700 Fax: +1-305-264-7890

FOR-A UK Limited

UNIT C71, Barwell Business Park, Leatherhead Road, Chessington Surrey, KT9 2NY, UK
Phone: +44 (0)20-8391-7979 Fax: +44 (0)20-8391-7978

FOR-A Italia S.r.l.

Viale Europa 50 20093, Cologno Monzese (MI), Milan, Italy
Phone: +39 02-254-3635/6 Fax: +39 02-254-0477

FOR-A Corporation of Korea

801 Dangsang Bld., 53-1 Dangsang-Dong, Youngdeungpo-Gu, Seoul 150-800, Korea
Phone: +82 (0)2-2637-0761 Fax: +82 (0)2-2637-0760

FOR-A China Limited

708B Huateng Building, No. 302, 3 District, Jinsong, Chaoyang, Beijing 100021, China
Phone: +86 (0)10-8721-6023 Fax: +86 (0)10-8721-6033