

# OPERATION MANUAL

---

**IVS-100**

Video Stabilizer

---

1<sup>st</sup> Edition





# Precautions



---

## Important Safety Warnings



### [Power]

 Caution	Operate unit <b>only</b> on the specified supply voltage.
	Disconnect power cord by connector only. <b>Do not</b> pull on cable portion.
 Stop	<b>Do not</b> place or drop heavy or sharp-edged objects on power cord. A damaged cord can cause fire or electrical shock hazards. Regularly check power cord for excessive wear or damage to avoid possible fire / electrical hazards.



### [Grounding]

 Caution	<b>Ensure</b> unit is properly grounded at all times to prevent electrical shock hazard.
 Hazard	<b>Do not</b> ground the unit to gas lines, units, or fixtures of an explosive or dangerous nature.

### [Operation]

 Hazard	<b>Do not</b> operate unit in hazardous or potentially explosive atmospheres. Doing so could result in fire, explosion, or other dangerous results.
 Hazard	<b>Do not</b> allow liquids, metal pieces, or other foreign materials to enter the unit. Doing so could result in fire, other hazards, or unit malfunction.
	If foreign material does enter the unit, turn power off and disconnect power cord <b>immediately</b> . Remove material and contact authorized service representative if damage has occurred.

## [Circuitry Access]

 A black circle with a white lightning bolt and a plug symbol, with a diagonal slash through it, indicating no power.	<p><b>Do not</b> remove covers, panels, casing, or access circuitry with power applied to the unit! Turn power off and disconnect power cord prior to removal. Internal servicing / adjustment of unit should only be performed by qualified personnel.</p>
 A black circle with a white hand symbol and a diagonal slash through it, indicating no touch. Stop	<p><b>Do not</b> touch any parts / circuitry with a high heat factor. Capacitors can retain enough electric charge to cause mild to serious shock, even after power is disconnected. Capacitors associated with the power supply are especially hazardous. Avoid contact with any capacitors.</p>
 A black triangle with a white lightning bolt and a flame symbol, indicating a hazard. Hazard	<p>Unit <b>should not</b> be operated or stored with cover, panels, and / or casing removed. Operating unit with circuitry exposed could result in electric shock / fire hazards or unit malfunction.</p>

## [Potential Hazards]

 A black triangle with a white lightning bolt symbol, indicating caution. Caution	<p>If abnormal smells or noises are noticed coming from the unit, turn power off immediately and disconnect power cord to avoid potentially hazardous conditions. If problems similar to above occur, contact authorized service representative <b>before</b> attempting to again operate unit.</p>
--	---

## [Consumables]

 A black triangle with a white exclamation mark symbol, indicating caution. Caution	<p>The consumables used in unit must be replaced periodically. For further details on which parts are consumables and when they should be replaced, refer to the specifications at the end of the Operation Manual. Since the service life of the consumables varies greatly depending on the environment in which they are used, they should be replaced at an early date. For details on replacing the consumables, contact your dealer.</p>
--	--

## [Rubber Feet]

 A black circle with a white exclamation mark symbol, indicating caution. Caution	<p>If this product has come with rubber feet attached by screws, do not insert the screws again without rubber feet after removing the rubber feet and screws. It may cause damage to the internal circuits or components of the unit. To install the rubber feet again to the unit, do not use other than the supplied rubber feet and screws.</p>
--	---

# Upon Receipt

---

## Unpacking

---

IVS-100 units and their accessories are fully inspected and adjusted prior to shipment. Operation can be performed immediately upon completing all required connections and operational settings.

Check your received items against the packing lists below.

ITEM	QTY	REMARKS
IVS-100	1	
AC adapter	1	
AC Cord	1	For AC adapter
AC adapter attachment bracket	1 set	
Operation Manual	1	

## Check

---

Check to ensure no damage has occurred during shipment. If damage has occurred, or items are missing, inform your supplier immediately.



# Table of Contents

---

1. Prior to Starting .....	1
1-1. Welcome .....	1
1-2. About the IVS-100.....	1
1-3. Usage Notes .....	2
1-4. About This Manual .....	2
2. Panel Descriptions .....	3
2-1. Front Panel .....	3
2-2. Rear Panel.....	4
3. Connection.....	5
4. Power ON .....	6
5. Menu Operation .....	7
5-1. Menu List .....	7
5-2. Operation Procedures.....	9
5-2-1. Menu Settings .....	9
6. Menu Description .....	11
6-1. Software/Hardware Version (1/16).....	11
6-2. Stabilize (2/16) .....	11
6-3. Correction Level (3/16) .....	11
6-4. Motion Filter (4/16).....	12
6-5. Enhance (5/16) .....	12
6-6. Anti-alias Filter (6/16).....	12
6-7. Effective Area (7/16) .....	13
6-8. Correction Area (8/16).....	15
6-9. Motion Detect Area (9/16).....	16
6-10. Uncorrected Character Area (Title Paste 10/16) .....	18
6-11. Direct Control (Direct Use 11/16) .....	20
6-12. Proc Amp (Process Control 12/16).....	21
6-13. Remote Control (13/16) .....	22
6-14. Menu Position (14/16).....	22
6-15. Video Signal Standard (Input Signal 15/16) .....	22
6-16. Menu Exit (16/16).....	22
6-17. Other Settings.....	23
6-17-1. OPERATE/BY-PASS .....	23
7. Remote Control.....	24
7-1. REMOTE Connector.....	24

7-1-1. Remote Terminal Equivalent Circuit .....	25
8. If Problems Occur.....	26
9. Specifications & Dimensions .....	27
9-1. Specifications .....	27
9-2. External Dimensions .....	28
Appendix. About Correction Range .....	29
1. About input and output images .....	29
2. Detection Range.....	31
3. Correction Range List.....	31



# 1. Prior to Starting

---

## 1-1. Welcome

---

Congratulations! By purchasing IVS-100 you have entered the world of FOR-A and its many innovative products. Thank you for your patronage and we hope you will turn to FOR-A products again and again to satisfy your video and audio needs.

FOR-A provides a wide range of products, from basic support units to complex system controllers, which have been increasingly joined by products for computer video based systems. Whatever your needs, talk to your FOR-A representative. We will do our best to be of continuing service to you.

## 1-2. About the IVS-100

---

The IVS-100 is a compact and DC-driven video stabilizer. It makes electrical corrections for video shaking occurring with a camera. It can be used in a wide range of monitoring systems, including those for highway monitoring, river monitoring, railroad track monitoring, steel-tower monitoring and weather cameras.

### Features

- Capable of correcting unsteady images in real time
- Corrects just unsteadiness while automatically recognizing panning and zooming
- Capable of correcting up to 40% in vertical/horizontal direction with respect to screen
- Provides sub-pixel level correction precision
- NTSC/PAL automatic selection
- Capable of being controlled remotely via the REMOTE connector on the rear panel
- Capable of setting Motion Detect Area for detecting motions in video to correct shaking

## 1-3. Usage Notes

---

- ◆ When shooting with the camera, use the highest possible shutter speed. Shooting moving objects with a slower shutter speed will result in a blurred and low-resolution image. A shutter speed of 1/240 sec. or less is recommended. This value, however, varies according to shooting subjects, shaking speed and other environments.
- ◆ Note that IVS-100 may not get proper results with some video images as below.

### **Images that appear flat**

Example: Images with uniform illumination of a wall or floor

### **Images with changing illumination in a single direction**

Example: Test signals such as Ramp/Color bar where the luminance level only changes horizontally, but not vertically.

### **Images with alternating changes in illumination**

Example: Images where an object such as a blind has changing light intensity that varies repeatedly at the same interval.

### **Images with multiple movements in different directions**

Example: Images where a big object crosses in front of the camera.

- ◆ If there is a rapid and drastic change of images such as camera switchover, images on the screen move as if they are panned and tilted. This may cause an unusual behavior and interfere the normal operation if the Motion Filter level is set high. After a certain period of time, however, the unit will automatically go back to the normal operation

To avoid such an unusual behavior and if an input of rapid and drastic change is found beforehand, set the "Stabilize" to OFF at the menu before that scene and to ON when the input image returns to normal. (See section 6-2 "Stabilize (2/16)" for menu setting.)

## 1-4. About This Manual

---

This manual is intended to help the user easily operate the IVS-100 and make full use of its functions during operations. Before connecting or operating your unit, read this operation manual thoroughly to ensure you understand the product. After reading, it is important to keep this manual in a safe place and available for reference.

## 2. Panel Descriptions

---

### 2-1. Front Panel

---

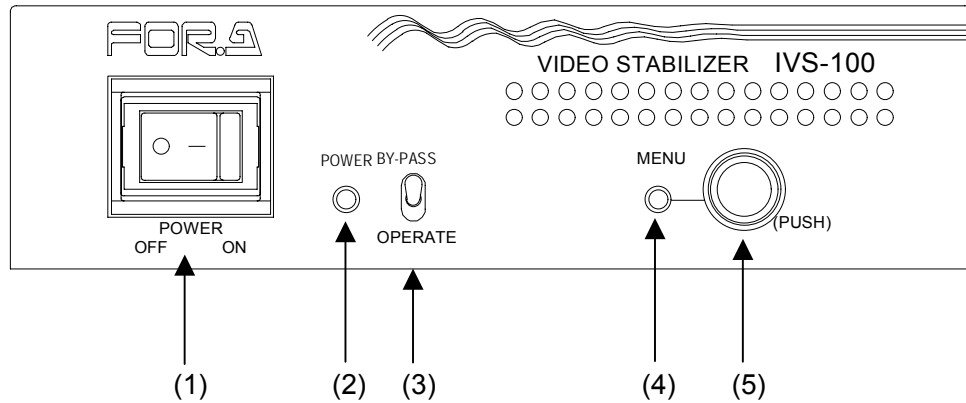

- (1) POWER switch  
Switch used to turn unit power ON / OFF.
- (2) POWER indicator  
Power indicator lights up green when the power switch is set to ON and power is applied to the unit.
- (3) OPERATE/BY-PASS toggle switch  
When this switch is set to OPERATE (bottom position), the IVS-100 performs correction and then outputs the input signals.  
When this switch is set to BY-PASS (top position), the IVS-100 outputs the input signal from VIDEO OUT1 without performing correction.  
See section 6-17-1. "OPERATE/BY-PASS" for more details.
- (4) MENU indicator  
Menu indicator lights up green while in the Menu mode.
- (5) Menu control  
Used to make operational settings in the Menu mode. Press and briefly hold the menu control (about 2 sec.) to enter the Menu mode.  
Parameters are changed (by turning the control clockwise or counterclockwise) and set (by pushing the control) while viewing the displayed information at the bottom of the screen.

## 2-2. Rear Panel

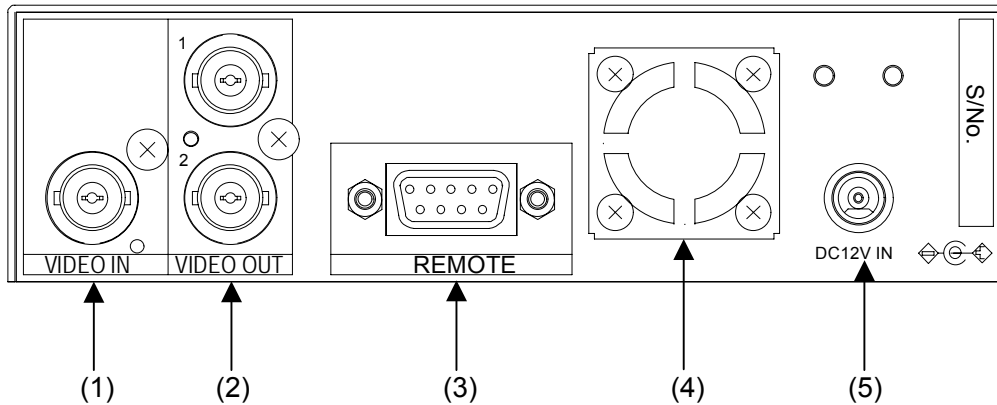

### (1) VIDEO IN

Used to input analog composite video signal.

### (2) VIDEO OUT 1/2

Used to output analog composite video signal. The connectors will output the corrected video input from (1) VIDEO IN if the OPERATE/BY-PASS switch on the front panel is set to OPERATE. The VIDEO OUT1 outputs the input image directly if the switch is set to BY-PASS or the unit power is OFF. The VIDEO OUT2 doesn't output any images if the unit power is OFF. See the table below.

VIDEO OUT	Power ON/OFF	OPERATE / BY-PASS Setting	Output Video Image
1	ON	OPERATE	Corrected image
		BY-PASS	Input image (uncorrected)
	OFF	---	Input image (uncorrected)
2	ON	OPERATE / BY-PASS	Corrected image
	OFF	---	None

### (3) REMOTE

Used for remote control connection. 9-pin D-sub female.  
See section "7-1. REMOTE Connector" for more details.

### (4) Fan

Used to air cool unit to prevent overheating. Do not block fan intake with other equipment or objects.

### (5) DC 12V IN

Used for connection to AC power source via supplied adapter and cable.

# 3. Connection

## ◆ Standard Connection Example

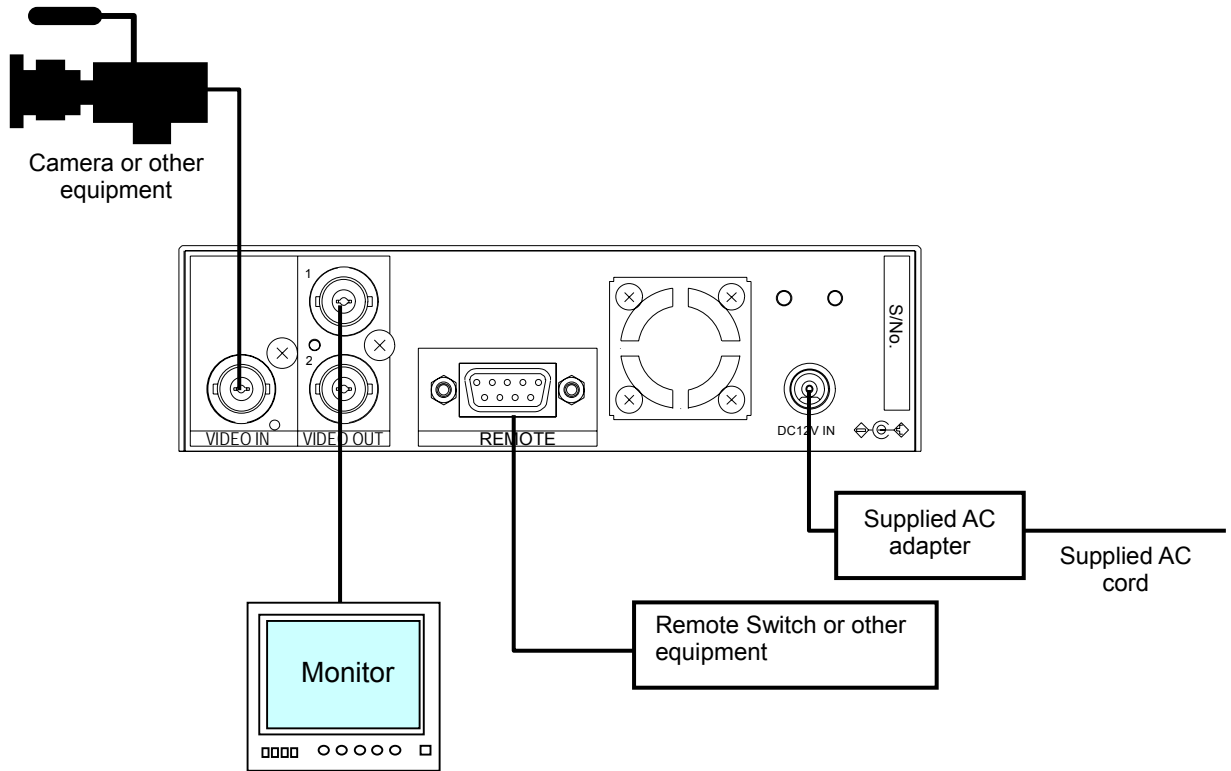

### IMPORTANT

OPERATE / BY-PASS setting determines whether the corrected video is output from VIDEO OUT1 or not. See section 2-2. "Rear Panel" for more details.

## 4. Power ON

---

### ◆ Startup Screen

When power is turned on, the last screen setup is displayed on the monitor. If MENU screen was displayed when power was turned OFF, the previous screen before the MENU screen will be displayed at power ON.

### ◆ Unit Reset

IVS-100 operation settings can be returned to factory defaults by the following procedures, as needed.

Turn the power switch ON with holding down the menu control and keep holding the control for a while until the message "INITIALIZE" appears. The IVS-100 returns to the factory default. See section 5-1. "Menu List" for the factory default settings.

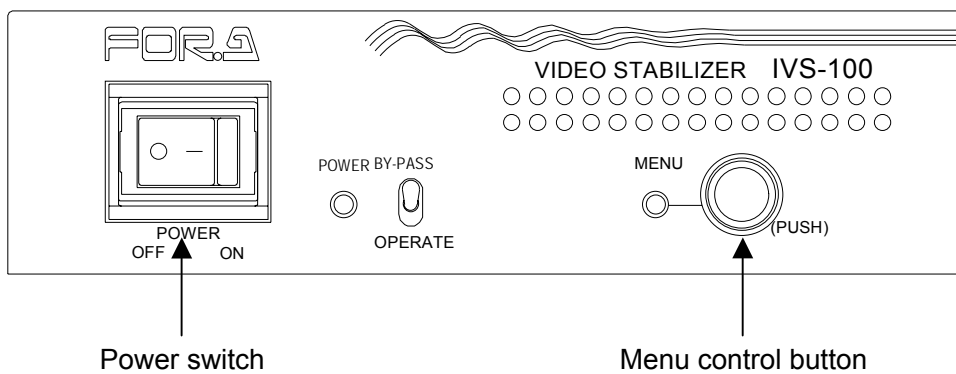

### ◆ Video Loss Indication

The power indicator will blink when input signal is not present because of the disconnection or other causes.

### ◆ To Enter Menu Mode

Press and hold the menu control button for about 2 seconds to enter the Menu mode.

# 5. Menu Operation

## 5-1. Menu List

This section provides a quick reference of all available IVS-100 menu settings in order of the menu display. See section 5-2-1. "Menu Settings" for more details. To make the operation easier, the Jog/Shuttle feature is available in the Motion Detect Area and Title Paste settings.

Menu No.	Parameter	Description	Default		Setting Range	Ref.			
1/16	Soft Version Hard Version	Displays the software / hardware version	-		Version (display only)	6-1			
2/16	Stabilize	Switches video shaking correction ON/OFF.	ON		ON / OFF	6-2			
3/16	Correction Level	Sets correction level.	10		0 - 15	6-3			
4/16	Motion Filter	Adjusts the filtering level for video stabilization.	HOR	7	0 - 16	6-4			
			VER	7	0 - 16				
5/16	Enhance	Adjusts edge enhancement.	HOR	10	0 - 15	6-5			
			VER	6	0 - 15				
6/16	Anti-alias Filter	Adjusts anti-alias.	VER	3	0 - 15	6-6			
7/16	Effective Area	Sets effective area.	4:3 (+0)		4:3 (+0) - 4:3 (+7) (8 steps) 16:9 (-7) - 16:9 (+7) (15 steps)		6-7		
					Adjust	Start_H		(+ 0) - (+50)	
						Start_V		(+ 0) - (+50)	
						End_H		(+ 0) - (+50)	
						End_V		(+ 0) - (+50)	
8/16	Correction Area	Sets correction area.	0		0 - 15	6-8			
9/16	Motion Detect Area	Sets motion detect area.	Normal		Normal		6-9		
					Adjust	NTSC		Start_H	18 - 310
								Start_V	12 - 197
								End_H	50 - 342
								End_V	44 - 229
					Adjust	PAL		Start_H	18 - 310
								Start_V	14 - 239
								End_H	50 - 342
End_V	46 - 271								

Menu No.	Parameter	Description	Default			Setting Range				Ref.
10/16	Title Paste	Specifies up to two character areas where the correction is not applied	1	OFF		Adjust	OFF			6-10
							NTSC	Start_H	67-413	
								Start_V	18-250	
								End_H	77-423	
			PAL	End_V	28-260					
				Start_H	73-414					
				Start_V	22-301					
End_H	83-424									
End_V	32-311									
11/16	Direct Use	Makes the parameter change directly without displaying menu.	OFF			OFF				6-11
						Correction Level				
						Motion Filter H				
						Motion Filter V				
12/16	Process Control	Proc Amp controls	Brightness	NTSC	247	0 - 255				6-12
				PAL	251					
			Contrast	NTSC	90	0 - 255				
				PAL	89					
			Chroma U	NTSC	116	0 - 255				
				PAL	124					
			Chroma V	NTSC	116	0 - 255				
				PAL	124					
			Hue	NTSC	0	0 - 255				
				PAL	0					
			Sharpness	NTSC	1	0 - 255				
				PAL	1					
			Gain	NTSC	208	0 - 255				
				PAL	208					
13/16	Remote Control	Changes operation mode.	OFF			OFF/ON				6-13
14/16	Menu Position	Changes menu position.	Bottom			Bottom/Upper				6-14
15/16	Input Signal	Displays input video signal format.	NTSC/PAL (AUTO detection)			NTSC/PAL (Display only)				6-15
16/16	Menu Exit	Exits the Menu mode	-			-				6-16



## 5-2. Operation Procedures

### 5-2-1. Menu Settings

The procedures for selecting menus and making settings and adjustments are shown below.

- (1) To display the menu screen, press and hold the menu control for about 2 seconds
- (2) Turn the menu control to select the desired menu item.

Parameter                      Menu No.

STABILIZE                      2/16

ON

↻:CHANGE      ⏏:ENTER



Turn

↑

Menu Control

↻: Turns the menu control clockwise.

↺: Turns the menu control counter - clockwise.

⏏: Presses the menu control.

- (3) The current setting is displayed on the screen.

CORRECTION LEVEL      3/16

5/15    (111%)

↻:CHANGE      ⏏:ENTER

- (4) Press the menu control. The menu number at the upper right will disappear and the parameter value will be flashing to indicate that change is enabled.

CORRECTION LEVEL

5/15    (111%)

↻: +    ↺: -    ⏏:ENTER



Press

↻: Flashing

- (5) Turn the menu control to change the setting value of the selected menu item.

CORRECTION LEVEL

7/15    (116%)

↻: +    ↺: -    ⏏:ENTER

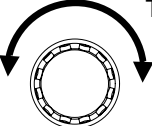

Turn

↻: Flashing

- (6) Press the menu control to apply the setting. The system automatically returns to the TOP menu.

CORRECTION LEVEL      3/16

7/15    (116%)

↻:CHANGE      ⏏:ENTER

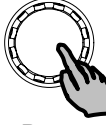

Press

#### IMPORTANT

If power is turned off during menu mode, a backup is not made and your changes will be lost. The backup operation is automatically made when the menu returns to the top and it is closed.

### ◆ TOP Menu

Only in the top level of the menu, a menu number is shown at the upper right of the display.

### ◆ Submenu

The procedure for submenu operation is the same as the procedure for menu operation. To return to the upper menu, select “-to TOP-” and press the menu control.

### ◆ Jog/Shuttle Mode

<Selecting the Shuttle Mode>

The Shuttle mode, a rapid control mode, is available in the submenus of Mot-Detect (Motion Detect) Area and Title Paste menus. Follow the procedure below to enter the Shuttle mode.

- 1) When the related parameter is selected, mode selection submenu is shown at the end of the menu.
- 2) Press the menu control when “Jog Mode” is displayed.
- 3) “Jog Mode” will start flashing.
- 4) Turn the menu control and select the Shuttle Mode.
- 5) Press the menu control to apply the setting

Repeat the same procedure to return to the Jog Mode.

<Operating in the Jog Mode (Normal control) >

- Turning the menu control one-step right (left) increments (decrements) the current setting value. To apply the setting, press the menu control.

<Operating in the Shuttle Mode>

- Turning the menu control one step right (left) gradually increases (decreases) the setting value. Turning the control one more step right (left) displays “>>”, and quickly increases (decreases) the setting value. To apply the setting, press the menu control.
- Four steps of speed are available in the Shuttle Mode and these steps of speed are expressed as the number of the code “>”. The normal speed is represented by “>”, while the highest speed is represented by “>>>>”.



## 6-4. Motion Filter (4/16)

---

MOTION FILTER determines the filtering level for video stabilization. The level can be set separately for Horizontal and Vertical in the range from 0 to 16.

Set higher to use a filter giving priority to video stabilization.  
Set lower to use a filter giving priority to smoothness.

Settings between 14 to 16 are effective for fixed point monitoring, such as for stationary cameras.  
Settings between 1 to 6 are effective for mobile cameras.

If you do not wish to set for Horizontal and Vertical separately, set to 0.

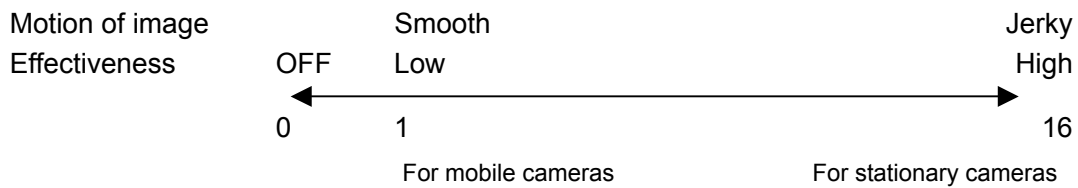

## 6-5. Enhance (5/16)

---

Used to set the enhancer function (edge enhancement).  
The level can be adjusted separately for Horizontal and Vertical in the range from 0 to 15.

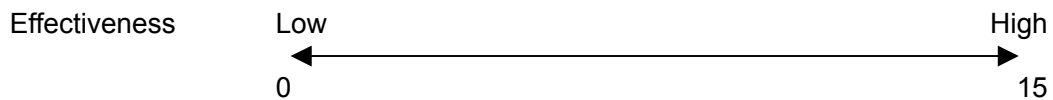

## 6-6. Anti-alias Filter (6/16)

---

The Anti-alias Filter menu is used to reduce the jagged diagonal lines when enlarging the images. This parameter can be set in the range from 0 to 15 levels. If set to 0, no anti-aliasing is applied, In contrast, setting to 15 applies the maximum strength of anti-alias.

## 6-7. Effective Area (7/16)

The “Effective Area” determines the region where the image is displayed. The “Effective Area” setting is useful to reduce edge noise, especially for the blackish noise (such as side panel and letterbox) caused by video conversion between 4:3 and 16:9 images.

### ◆ Setting the Effective Area

- 1) Select the Effective Area menu.
- 2) While monitoring the VIDEO OUT image, set the Effective Area. This setting affects both the width and height at the same ratio. Use 4:3 settings in normal case. Use 16:9 settings for letterbox type. Setting the number value in the parentheses adjusts both the width and the height at the same time on a 2-pixel resolution.

Setting Range
4:3 (+0) to 4:3 (+7) (8 steps)
16:9 (-7) to 16:9 (+7) (15 steps)

The aspect ratio is represented by 16:9 or 4:3.  
The number in the parentheses represents value for adjustment on a 2-pixel resolution.

- 3) When “Adjust” is selected, following four parameters are appeared. Use these four parameters to finely adjust the Effective Area.

Parameter	Setting Range
Start_H	(+ 0) to (+50) (51 steps)
Start_V	(+ 0) to (+50) (51 steps)
End_H	(+ 0) to (+50) (51 steps)
End_V	(+ 0) to (+50) (51 steps)

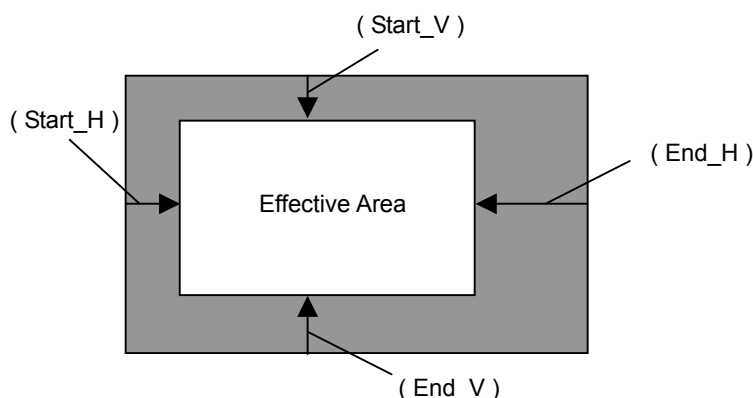

### IMPORTANT

While setting the Effective Area, a rectangle or a masked region that indicates the Effective Area will be displayed on VIDEO OUT output screen. After the setting has been completed, the rectangle region will disappear. Note that setting the “Effective Area” lets the “Correction Area and “Motion Detect Area” return to factory default settings.

◆ **Effective Area Setting Example**

The correction is made without setting an Effective Area, however, blackish noise may appear if input video has cut off areas as shown below. Effective Area is useful to reduce such a noise.

**Preset Value Setting**

Using preset values is effective when black bars are added at both upper and lower or right and left sides of the video edge.

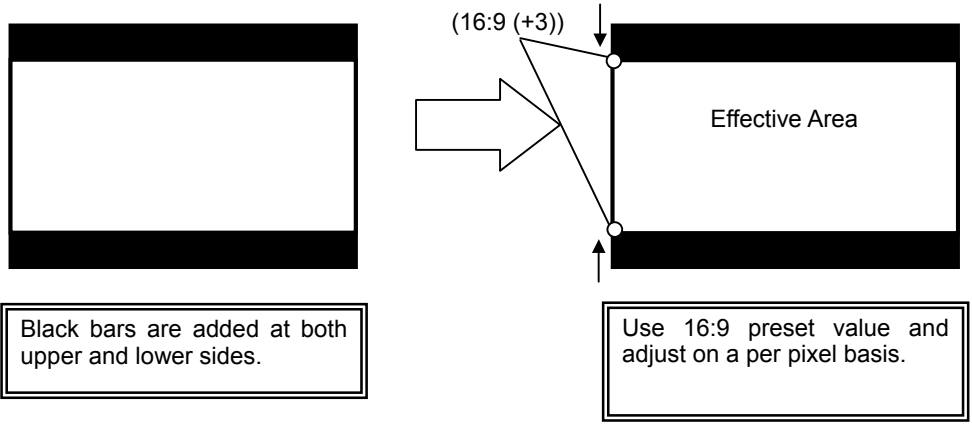

**Detailed Setting with Adjust**

Using Adjust setting is effective when cut off area or blackish noise is around the edge of the video.

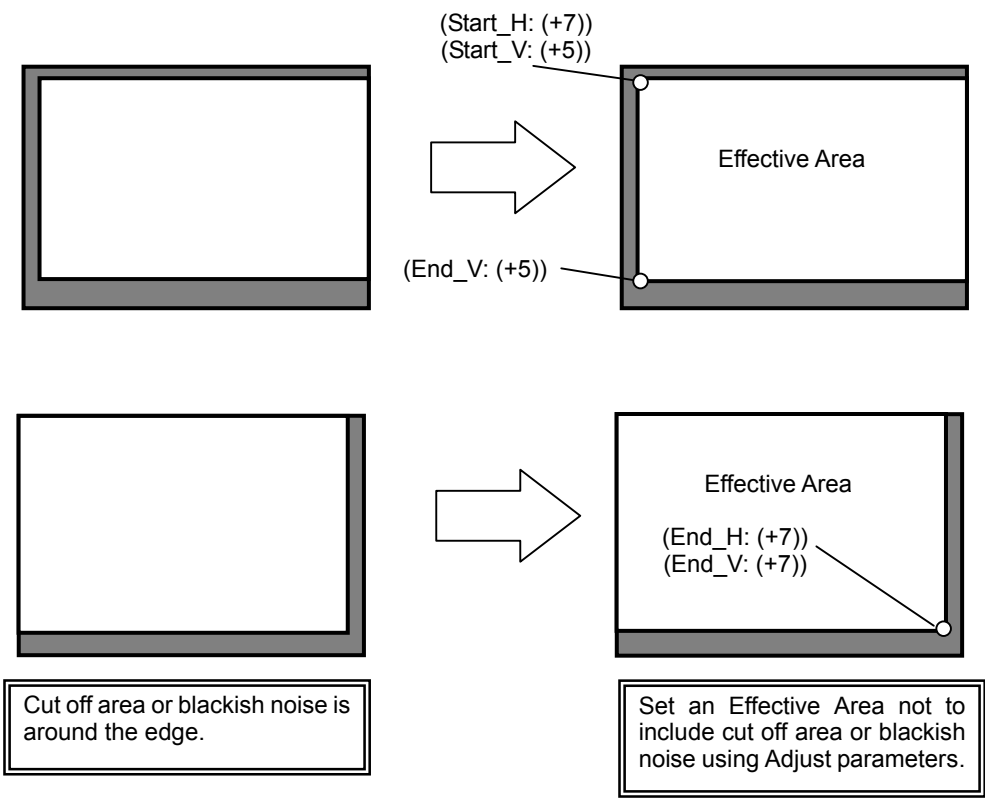



## 6-9. Motion Detect Area (9/16)

The “Motion Detect Area” determines the region where the Video Shaking Correction (Stabilize) is applied. This feature distinguishes the irregular motions such as motions in reverse direction, captions and times on the video from the total shaking of the video. It can further refine the quality of shaking detection.

### ◆ Setting the Motion Detect Area

- 1) Select the Mot-Detect Area menu.
- 2) While monitoring the VIDEO OUT image, set the Mot-Detect Area.
- 3) When “Adjust” setting is selected, the Motion Detect Area can be set by the parameter of the upper left corner point (Start-H, Start-V) and the lower right corner point (End-H, End-V) of the rectangular area (See the figure below).

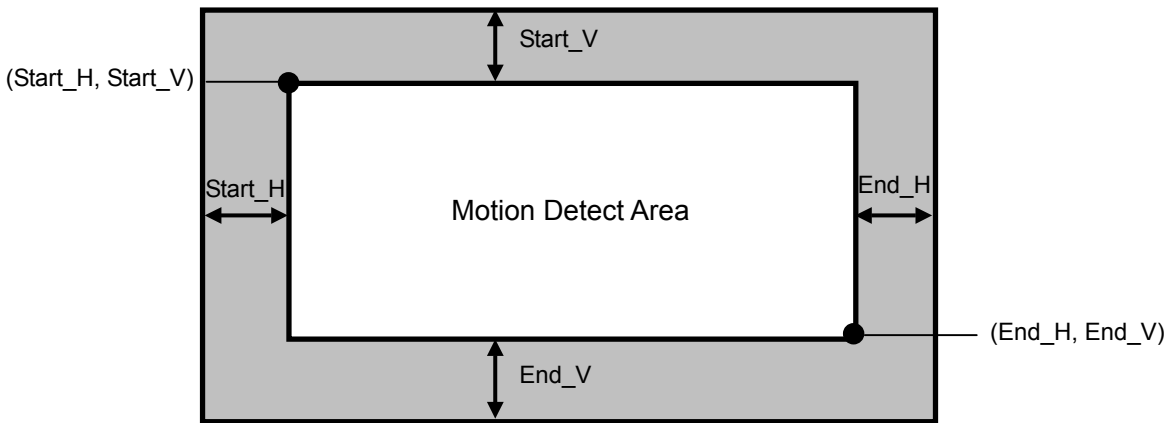

#### Setting Range of the Motion Detect Area (NTSC)

Start_H	18 to 310	Start_V	12 to 197
End_H	50 to 342	End_V	44 to 229

#### Setting Range of the Motion Detect Area (PAL)

Start_H	18 to 310	Start_V	14 to 239
End_H	50 to 342	End_V	46 to 271

#### NOTE

The Jog/Shuttle mode is available when the Mot-Detect Area parameter is set to Adjust. See section 5-2-1. “Menu Settings ◆Jog/Shuttle Mode” for more details.



◆ How to use the Adjust settings effectively

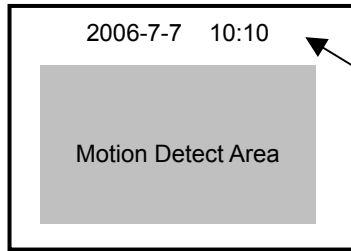

If the input video consists of a video and a superimposed title such as time display, exclude the title (still images) from the Motion Detect Area.

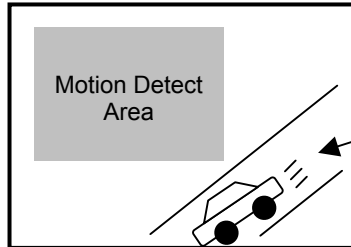

If the fast moving objects (such as cars) always pass over the specific position of the camera, exclude those objects from the Motion Detect Area so as not to be affected by those

**IMPORTANT**

The Motion Detect Area cannot be set smaller than 32 (width) x 32 (height).

Note that the system will produce the marker signal to indicate the Motion Detect Area while the Motion Detect Area setting. After the setting has been completed, the marker signal will disappear.

## 6-10. Uncorrected Character Area (Title Paste 10/16)

If input video has a character area such as captions, times, dates etc. and the shaking correction is applied to the video, the characters may appear blurred or in multiple images on screen contrary to the video. In this case, use the Title Paste feature to specify a character area where the correction is not applied. Up to two character areas (TITLE1 and TITLE2) can be specified.

### ◆ Title Paste Settings

- 1) Select TITLE 1 or TITLE 2 in the Title Paste menu.
- 2) When specifying a Motion Detect area, set it without including character areas.
- 3) Change from OFF and specify a Title Paste area by setting 4 points (Start\_H, Start\_V, End\_H and End\_V). See the figure below..

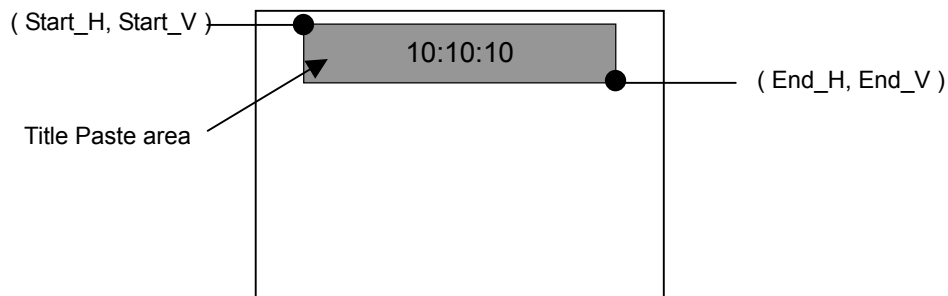

#### Setting Range (NTSC)

Start_H	67 to 413	Start_V	18 to 250
End_H	77 to 423	End_V	28 to 260

#### Setting Range (PAL)

Start_H	73 to 414	Start_V	22 to 301
End_H	83 to 424	End_V	32 to 311

#### NOTE

The Jog/Shuttle mode is available when the TITLE1 or TITLE2 parameter is set to Adjust. See section 5-2-1. "Menu Settings ◆Jog/Shuttle Mode" for more details.

◆ When the Title Paste is not used:

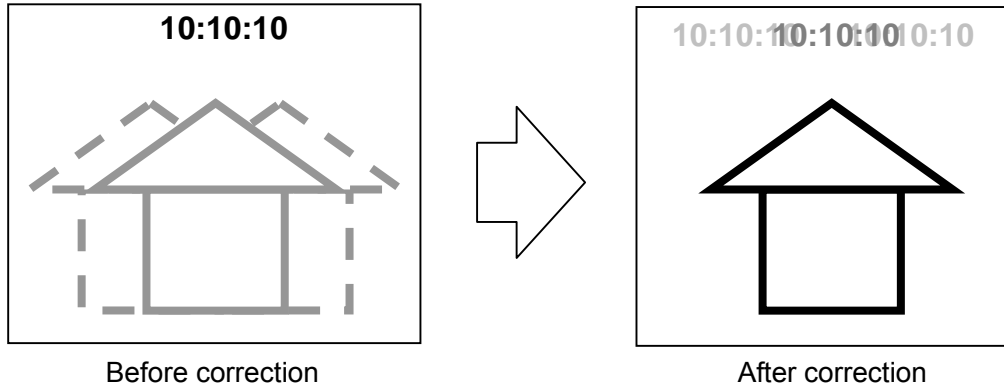

The video shaking is corrected, however, the time is blurred and hard to read.

◆ When the Title Paste is used:

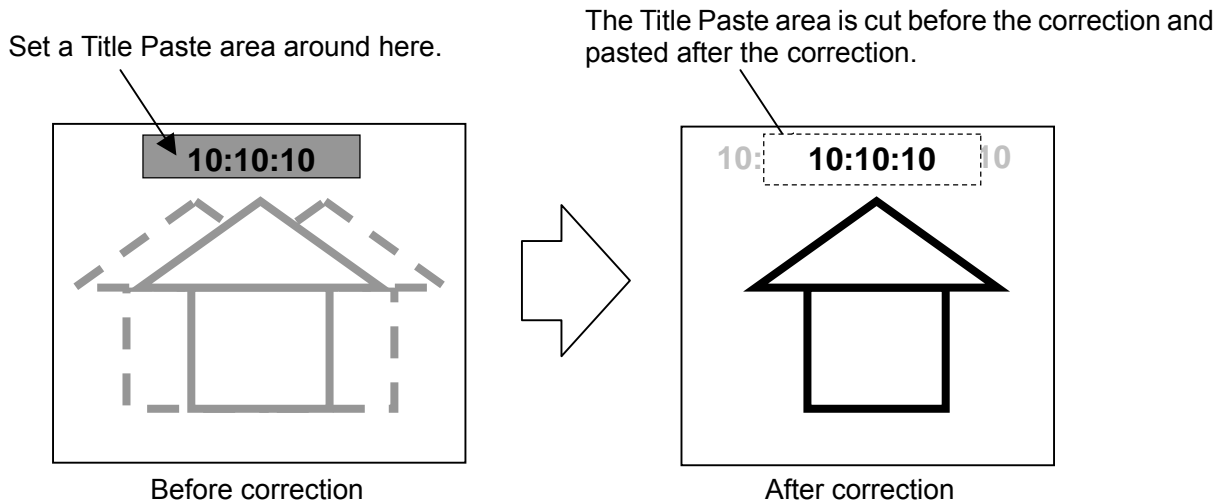

The video shaking is corrected and the time is not blurred and easy to read.

**NOTE**

Title Paste areas must be set smaller than 10 (H) x 10 (V).

In the following conditions, setting a Title Paste area after masking it with Effective Area is recommended.

- When a caption or time is large, or when a caption is clear, however, image around the caption is not clear: In this case, the quality of the correction may be decreased without masking.
- When blurred characters or numbers of caption or time are displayed around the Title Paste area:

## 6-11. Direct Control (Direct Use 11/16)

---

The Direct Use feature allows direct control of parameter only by turning the menu control without showing menu. Any one of the following three parameters can be set for direct control. The factory default setting is OFF (none).

### ◆ Available Parameters

Correction Level  
Motion Filter H  
Motion Filter V

Parameter	Setting Range	Default	Operation
Correction Level	0 to 15	10	Increasing value: Turn the menu control clockwise
Motion Filter H	0 to 16	7	
Motion Filter V	0 to 16	7	Decreasing value: Turn the menu control counter-clockwise

#### NOTE

Enter menu mode if you want to verify the value of the Direct Use parameter.  
The Direct Use parameter can be also set by the normal menu operation.

## 6-12. Proc Amp (Process Control 12/16)

The following Proc Amp parameters can be adjusted in the Process Control menu. They are factory set to as shown in the table below and normally do not need to be changed. Change them only when as needed.

Parameter	Description	Setting Range	Default	
			NTSC	PAL
Brightness	Adjusts luminance of video signal.	0 to 255	247	251
Contrast	Adjusts contrast of video signal.	0 to 255	90	89
Chroma U	Adjusts chroma U component of video signal.	0 to 255	116	124
Chroma V	Adjusts chroma V component of video signal.	0 to 255	116	124
Hue	Adjusts hue of video signal.	0 to 255	0	0
Sharpness	Adjusts sharpness of video signal. Sharpness may improve the clearness of the image if the correction is not effective.	0 to 15	1	1
Gain	Adjusts gain of video signal.	0 to 255	208	208
Current Menu Default	Returns to the default settings.	-	-	-

Current Menu Default can return all the parameters in the Process Control menu to the factory default. Current Menu Default displays a pop-up confirming if you really want to reset values, when it is selected. Selecting "No" returns to the menu display without making any changes. Selecting "Yes" returns all the parameters in the Process Control to the factory default.

The figure below shows the system flow of the IVS-100. The Proc Amp is applied at Step (a) in the figure.

### ◆ System Flow

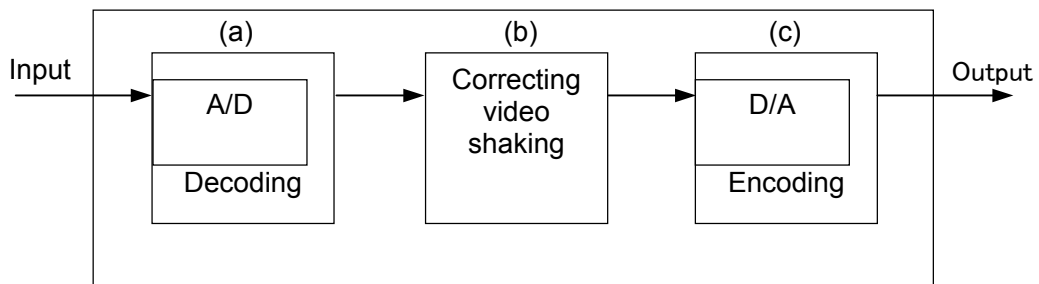

## 6-13. Remote Control (13/16)

---

To enable the remote control of the unit, set Remote Control to ON. See section 7. "Remote Control" for more details.

IMPORTANT
The OPERATE/BY-PASS toggle switch is disabled and the Stabilize setting cannot be changed via the menu during the remote control session.

## 6-14. Menu Position (14/16)

---

The menu position can be changed in the Menu Position menu.

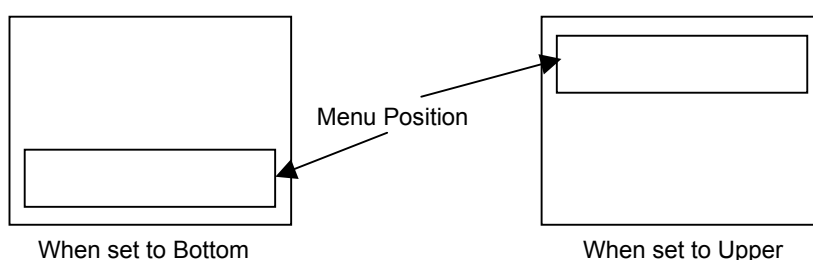

## 6-15. Video Signal Standard (Input Signal 15/16)

---

The current input video signal format can be viewed in the Input Signal menu.

Input Video Signal Format	NTSC, PAL
---------------------------	-----------

## 6-16. Menu Exit (16/16)

---

To exit the Menu mode, press the menu control in the Menu Exit menu.

NOTE
You can also exit the Menu mode by pressing and holding the menu control for about 2 seconds.

## 6-17. Other Settings

### 6-17-1. OPERATE/BY-PASS

You can use the toggle switch on the front panel to switch the OPERATE/BY-PASS setting.

◆ **If set to OPERATE:**

When the OPERATE/BY-PASS switch is set to OPERATE, the corrected video signals are output.

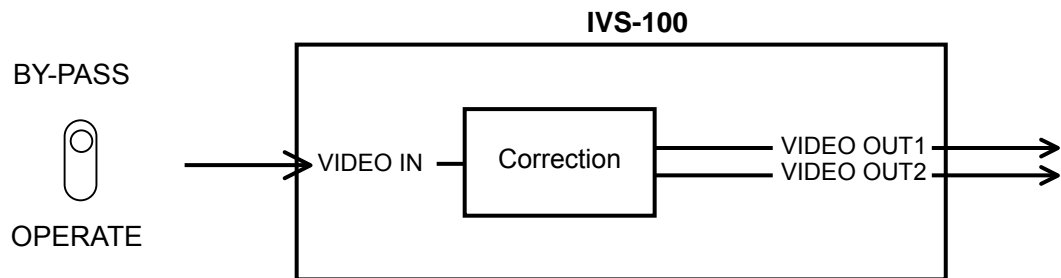

**IMPORTANT**

If Stabilize is set to OFF in the menu, the signals are not corrected, but the magnification percentage in the Correction Level setting is still enabled.

The OPERATE/BY-PASS toggle switch is disabled during the remote control session.

◆ **If set to BY-PASS:**

When the OPERATE/BY-PASS switch is set to BY-PASS, the input signal is directly output from VIDEO OUT1, and a corrected video signal is output from VIDEO OUT2.

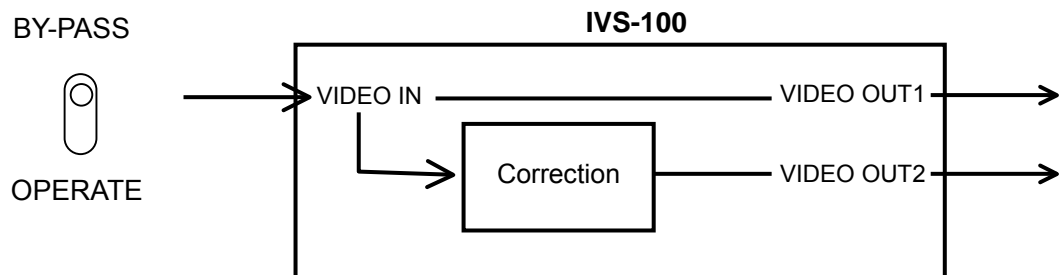

# 7. Remote Control

To enable the remote control of the unit, set Remote Control to ON. See section 6-13. "Remote Control (13/16)" for more details.

## 7-1. REMOTE Connector

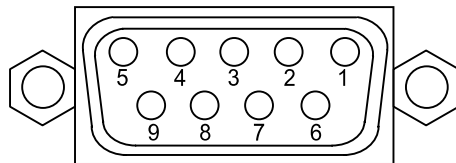
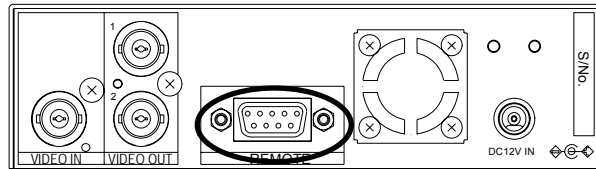

◆ REMOTE Connector Pin Assignment Table (9-pin D-sub, female)

Pin No.	Signal Details	I/O	Function	High	Low
1	VCC		+5V		
2	OPERATE / BY-PASS	Output	See section 6-17.	BY-PASS	OPERATE
3	VIDEO IN	Output	Input video/None	None	Input video
4	Not Used	—	—		
5	Stabilize	Output	See section 6-2.	OFF	ON
6	OPERATE / BY-PASS	Input	See section 6-17.	OPERATE	BY-PASS
7	Stabilize	Input	See section 6-2.	ON	OFF
8	Not Used	—	—		
9	GND		GND		

### IMPORTANT

**Do not** connect any devices to Pin4 or Pin8 except the remote controller used with the IVS-300/300A.



## 7-1-1. Remote Terminal Equivalent Circuit

### ◆ Example of connection with remote output circuit

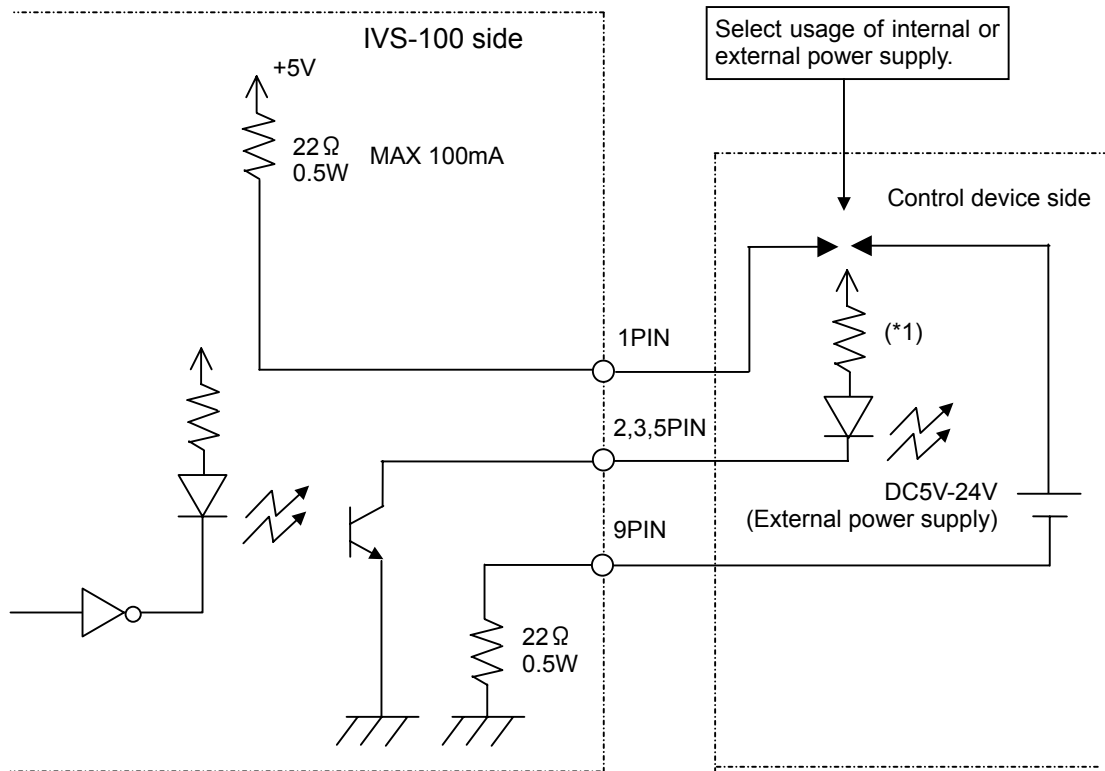

(\*1) Use a protective resistance at the proper value according to the internal/external supply voltage and LED characteristics. The maximum load current of each is 30mA.

### ◆ Example of connection with remote input circuit

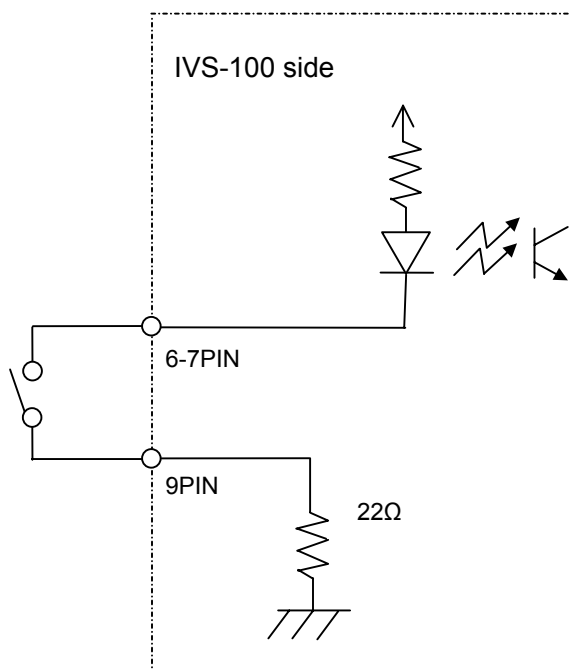

## 8. If Problems Occur

---

If any of the following problems occur during operation of your IVS-100, proceed as indicated below to see if problem can be corrected before assuming a unit malfunction has occurred.

Problem	Check	Action
Cannot change between OPERATE and BY-PASS.	Remote Control setting	Verify that Remote Control is set to OFF
Input video signal not bypassed when powered OFF.	VIDEO OUT connectors	Verify that the cable is connected to VIDEO OUT1. (BY-PASS is not available for VIDEO OUT2)
Need to return all settings to the factory default.		Turn on the power while holding the menu control on the front panel The backed up data is also reset to the factory default.

## 9. Specifications & Dimensions

---

### 9-1. Specifications

---

Video Standard	NTSC or PAL (automatic selection)
Video Input	Analog composite: 1.0V p-p, 75 $\Omega$ , BNC 1 inputs (only when Power ON)
Video Outputs	Analog composite: 1.0V p-p, 75 $\Omega$ , BNC, 2 outputs (Only OUT1 can bypass the input.)
Output Image Size	711x484 pixels (NTSC), 702x575 pixels (PAL) Image size varies according to the input image size and Correction Level setting in the menu.
Total Delay	3 frames max.
Correction Function	Correction range: maximum 40 percentage for both vertical and horizontal
Frequency Response	Detectable range is from 1Hz to a half of the field frequency (theoretical value).
Motion Type	Vertical, horizontal, and diagonal (two-dimensional)
Interfaces	REMOTE: 9-pin D-sub, 1ea. (female) TTL negative logic level or make contact (max. 5V to 24VDC 40mA)
Temperature	0°C–40 °C
Humidity	30%–90% (no condensation)
Power	12VDC–24VDC
Consumption	8.1W at 12VDC
Dimensions	145 (W) x 162 (D) x 40 (H) mm
Weight	0.85 kg
Consumables	Cooling fan: P-1366 (at rear panel) Change every 5 years at normal temperature.
 <AC Adapter>	
Power	100 VAC–240 VAC $\pm$ 10%, 50 Hz/60 Hz
Consumption	18.2VA (11.0W) at 100VAC 20.4VA (10.7W) at 200VAC
Dimensions	62 (W) $\times$ 99 (D) $\times$ 26 (H) mm

## 9-2. External Dimensions

(All dimensions in mm)

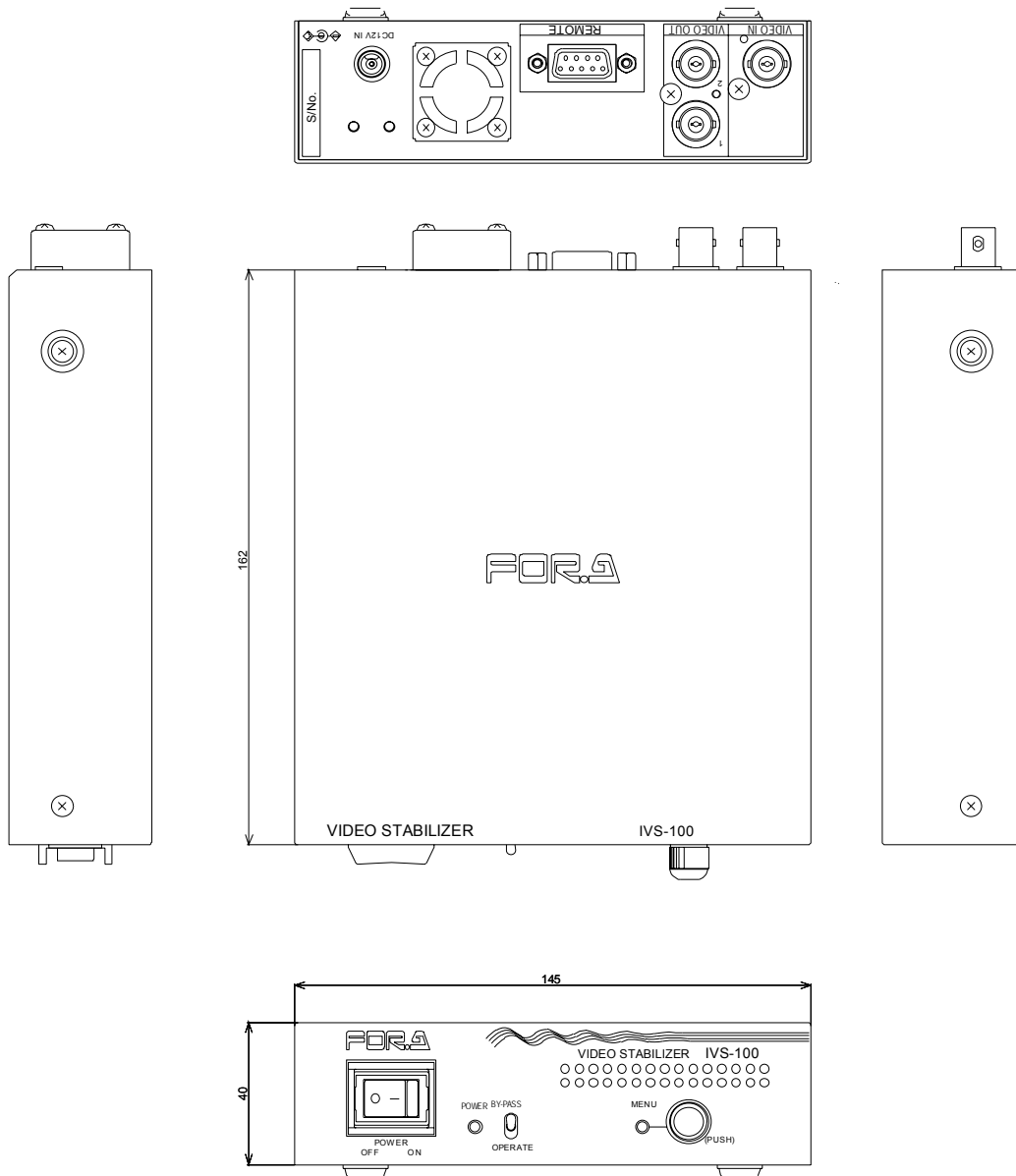

# Appendix. About Correction Range

---

## 1. About input and output images

---

The IVS-100 removes motion by magnifying the input image and then smoothing out jitters and shakes in the image to output a steady image. The basic process is described below.

### ◆ Input video image

The process for an input video image that shakes horizontally is shown below.

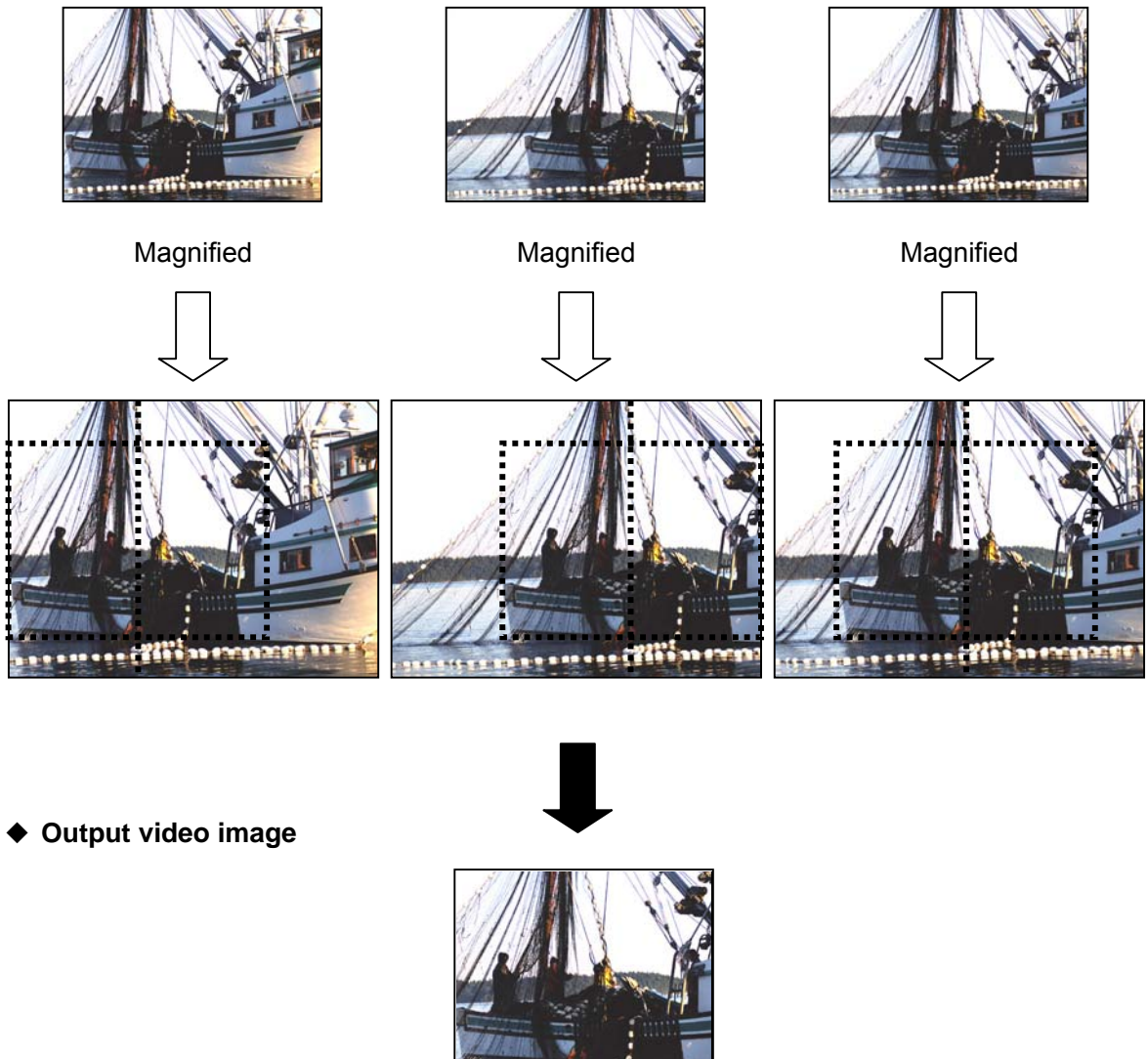

### ◆ Output video image

The shaky input video image shown above is magnified, and then an output image is extracted from this magnified image based on the detected motion to give a steady output image without any shakes or jitters.

You can see that the corrected video is magnified according to the Correction Level setting by comparing an uncorrected bypass video with a corrected video through a monitor by toggling the OPERATE/BY-PASS switch on the front panel. In the examples shown below, the image area enclosed by bold lines is monitored. A steady video is output by sliding within the correction range according to the detected motion.

◆ **Input video image**

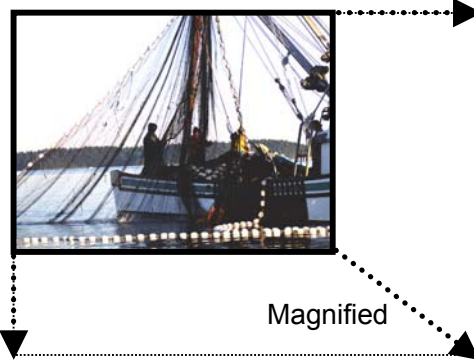

◆ **Output video image**

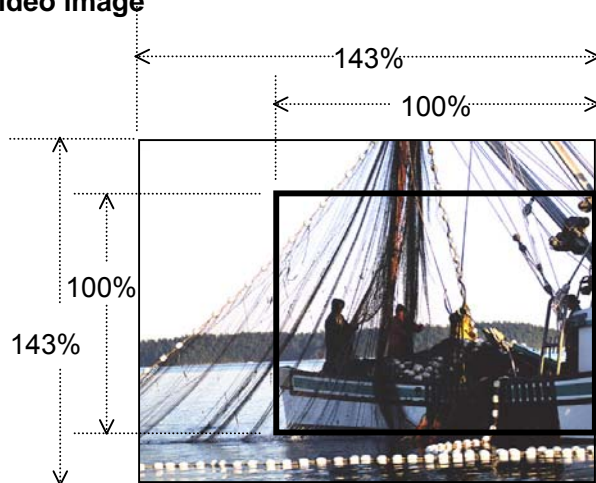

If Correction Level set to 15 (143%)

If the Correction Level is set to 15 (143 %), the percentage of the correction range in the input image should be:  $43/143 \doteq 30\%$

Refer to Appendix section 3. "Correction Range List" for more information about the relationship between Correction Level setting and the percentage of the correction ranges in input image.

## 2. Detection Range

---

Horizontal direction: Max.  $\pm 62$  pixels (Detection accuracy: 0.02 pixel)  
 Vertical direction: Max.  $\pm 62$  lines (Detection accuracy: 0.02 line) (frame based)

\* The IVS-100 detects the amount of motion between fields.

## 3. Correction Range List

---

Correction Level	Percentage of correction range in input image (approx.)			
	NTSC		PAL	
	Horizontal (%)	Vertical (%)	Horizontal (%)	Vertical (%)
0 (100%)	1	1	1	1
1 (102%)	3	2	3	3
2 (104%)	2	4	3	5
3 (106%)	4	6	5	6
4 (108%)	5	8	7	8
5 (111%)	8	10	9	10
6 (114%)	9	12	11	12
7 (116%)	11	14	13	14
8 (119%)	13	16	15	17
9 (122%)	15	18	17	18
10 (125%)	17	20	19	20
11 (128%)	19	22	21	23
12 (131%)	21	24	23	25
13 (135%)	23	26	25	27
14 (139%)	25	28	27	28
15 (143%)	27	30	29	31

Correction accuracy Horizontal direction: 0.02 pixel  
 Vertical direction: 0.02 line (frame based)





## **Warning**

This equipment has been tested and found to comply with the limits for a Class A digital device, pursuant to Part 15 of FCC Rules. These limits are designed to provide reasonable protection against harmful interference when the equipment is operated in a commercial environment. This equipment generates, uses, and can radiate radio frequency energy and, if not installed and used in accordance with the instruction manual, may cause harmful interference to radio communications. Operation of this equipment in a residential area is likely to cause harmful interference, in which case the user will be required to correct the interference at his own expense.



**FOR-A COMPANY LIMITED**

Head Office : 3-8-1 Ebisu, Shibuya-ku, Tokyo 150-0013, Japan  
Overseas Division Phone: +81 (0)3-3446-3936, Fax: +81 (0)3-3446-1470  
Japan Branch Offices : Osaka/Okinawa/Fukuoka/Hiroshima/Nagoya/Sendai/Sapporo  
R&D/Production : Sakura Center/Sapporo Center

**FOR-A America Corporate Office**

1125 Knott Ave., Suite #A, Cypress, CA 90630, USA  
Phone: +1 714-894-3311 Fax: +1 714-894-5399

**FOR-A America East Coast Office**

Two Executive Drive, Suite 670, Fort Lee Executive Park, Fort Lee NJ 07024, USA  
Phone: +1 (201) 944-1120 Fax : +1 (201) 944-1132

**FOR-A America Distribution & Service Center**

2400 N.E. Waldo Road, Gainesville, FL 32609, USA  
Phone: +1 352-371-1505 Fax: +1 352-378-5320

**FOR-A Corporation of Canada**

346A Queen Street West, Toronto, Ontario M5V 2A2, Canada  
Phone: +1 416-977-0343 Fax: +1 416-977-0657

**FOR-A Latin America & the Caribbean**

5200 Blue lagoon Drive,  
Suite 760, Miami, FL 33126, USA  
Phone: +1-305-931-1700 Fax: +1-305-264-7890

**FOR-A UK Limited**

UNIT C71, Barwell Business Park, Leatherhead Road, Chessington Surrey, KT9 2NY, UK  
Phone: +44 (0)20-8391-7979 Fax: +44 (0)20-8391-7978

**FOR-A Italia S.r.l.**

Viale Europa 50 20093, Cologno Monzese (MI), Milan, Italy  
Phone: +39 02-254-3635/6 Fax: +39 02-254-0477

**FOR-A Corporation of Korea**

801 Dangsang Bld., 53-1 Dangsang-Dong, Youngdeungpo-Gu, Seoul 150-800, Korea  
Phone: +82 (0)2-2637-0761 Fax: +82 (0)2-2637-0760

**FOR-A China Limited**

708B Huateng Building, No. 302, 3 District, Jinsong, Chaoyang, Beijing 100021, China  
Phone: +86 (0)10-8721-6023 Fax: +86 (0)10-8721-6033