

Universal System Frame **USF-Series**

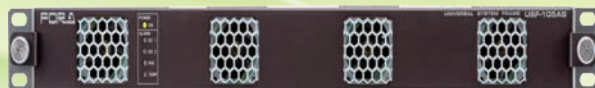

USF-105AS



USF-212BS

Universal modular frame designed for compact, economical system building. Build an optimal system for your environment from a full array of modules.

- Available frames.
 1RU size. Holds up to 5 modules: USF-105AS.
 2RU size. Holds up to 12 modules: USF-212BS.
- Hot-swappable, front-accessible power unit and module bays.
- New design combining SDI and Ethernet.
- 2 genlock inputs (black burst (BB) or tri-level sync) (USF-212BS), 1 genlock input (USF-105AS).
- Built-in gigabit Ethernet hub for GUI-based module configuration.
- Frame operational monitoring (cooling fan and power) and module life-and-death monitoring using SNMP.

Available modules

Below is the maximum number of modules mounted on each frame. For details, contact your FOR-A dealer.

Module \ Frame	USF-212BS	USF-212AS*1	USF-212S*1	USF-105AS	USF-105S*1
USF-10IPSDI12-FS	3	3	3	—	—
USF-10IPSDI6-FS	5	5	5	—	—
USF-10IP-TRC-FS	3	—	—	—	—
USF-10IP-TRC	5	—	—	—	—
USF-106TICO-12G	6	6	6	2	—
USF-1043FS	12	12	12	5	5
USF-105FS-12G	12	12	12	3	—
USF-106UDC-12G	6	6	6	2	—
USF-106DC-12G	6	6	6	2	—
USF-111DDA-12G	6	6	6	2	—
USF-105DDA-12G	12	12	12	5	—
USF-1053DDA	12	12	12	5	5
USF-1043VM	12	12	12	5	5
USF-1100VEA	6	6	6	2	2
USF-1040VEA	12	12	12	5	5
USF-105DADA	12	12	12	5	5
USF-108ADA	12	12	12	5	5
USF-204ADAC	12	12	12	5	5
USF-402AADC	12	12	12	5	5
USF-101MDX4-12G	6	6	6	2	—
USF-101MDX8-12G	6	6	6	2	—
USF-1013MUX	12	12	12	5	5
USF-1013DEMUX	12	12	12	5	5
USF-80SDICS*2	12	12	12	5	5

*1 End of sale. Choose from USF-212BS or USF-105AS for a new purchase of the frames.

*2 USF Web GUI can't confirm mounted state and version of USF-80SDICS. Dedicated GUI is required to confirm state and monitor.

Available modules

USF-10IP-TRC

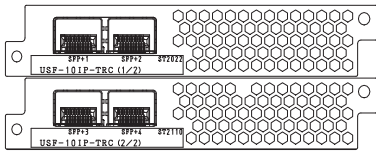

SMPT E ST 2022-8 ↔ SMPT E ST 2110 conversion

- IP format: SMPT E ST 2022-8, SMPT E ST 2110.
- IP synchronization: PTP (SMPT E ST 2059).
- Four 10 GbE (SFP+) port supports hitless operation for redundancy (SMPT E ST 2022-7).
- Control: Web GUI, NMOS (IS-04/05 In-band).

※ Up to 5 USF-10IP-TRC modules can be installed into USF-212BS.

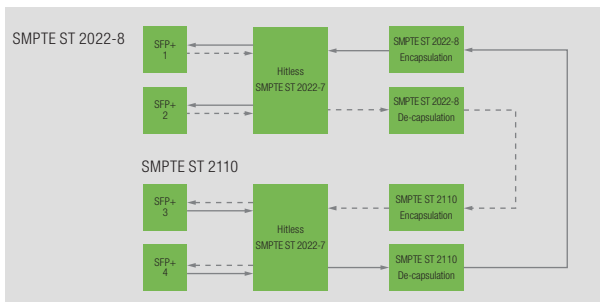

USF-10IP-TRC-FS

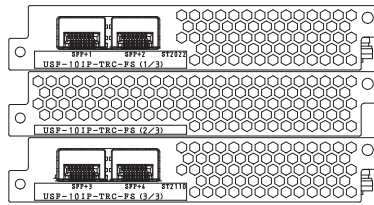

SMPT E ST 2022-6 ↔ SMPT E ST 2110 conversion

- IP format: SMPT E ST 2022-6, SMPT E ST 2110.
- IP synchronization: PTP (SMPT E ST 2059). Equipped with frame synchronization to synchronize SMPT E ST 2022-6 sources using PTP.
- Four 10 GbE (SFP+) port supports hitless operation for redundancy (SMPT E ST 2022-7).
- Control: Web GUI, NMOS (IS-04/05 In-band).

※ Up to 3 USF-10IP-TRC-FS modules can be installed into USF-212BS.

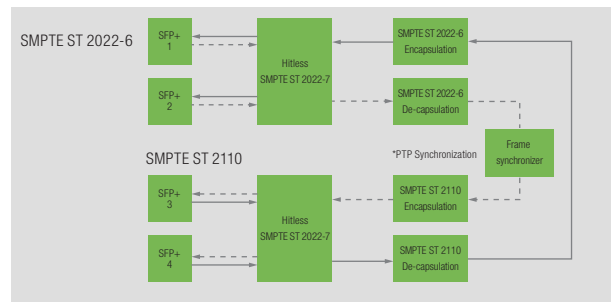

USF-10IPSDI6-FS

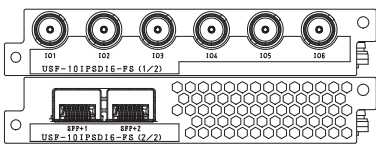

IP ↔ SDI conversion

- IP format: SMPT E ST 2022-6/8, SMPT E ST 2110 (used by switching, cannot be mixed).
- IP synchronization: PTP (SMPT E ST 2059).
- Frame synchronizer: Selectable from sync signal generated from PTP or external BB input.
- Two 10 GbE (SFP+) port supports hitless operation for redundancy (SMPT E ST 2022-7).
- Video format : 1080/59.94p, 1080/50p, 1080/59.94i, 1080/50i.
- Conversion of up to 6 streams. 3G-SDI: 3 inputs/3 outputs. HD-SDI: Up to 6 inputs or 6 outputs, or 3 inputs/3 outputs.
- Compresses 12G-SDI to 3G/1.5G-SDI and processes 4K signals by using codec module USF-106TICO-12G simultaneously with input/output signals.
- Control: Web GUI, NMOS (IS-04/05 In-band).

※ Up to 5 USF-10IPSDI6-FS modules can be installed into USF-212BS.

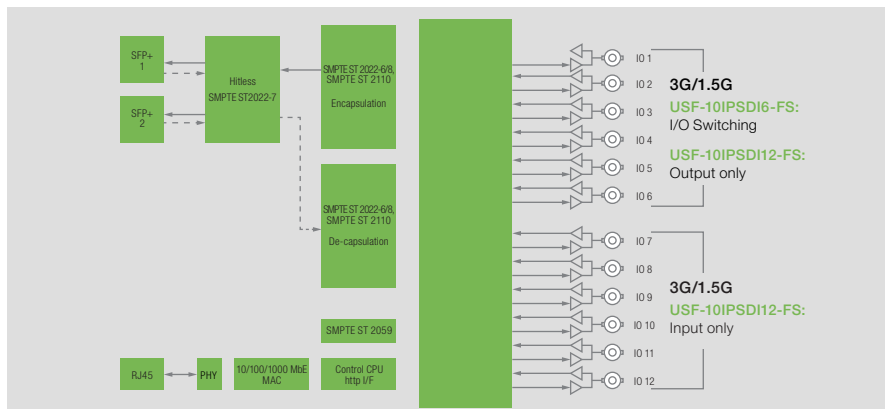

USF-10IPSDI12-FS

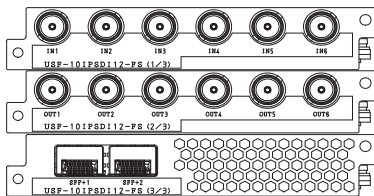

IP ↔ SDI conversion

- IP format: SMPT E ST 2022-6/8, SMPT E ST 2110 (used by switching, cannot be mixed).
- IP synchronization: PTP (SMPT E ST 2059).
- Frame synchronizer: Selectable from sync signal generated from PTP or external BB input.
- Two 10 GbE (SFP+) port supports hitless operation for redundancy (SMPT E ST 2022-7).
- Video format: 1080/59.94p, 1080/50p, 1080/59.94i, 1080/50i.
- Conversion of up to 12 streams. 3G-SDI: 3 inputs/3 outputs. HD-SDI: Up to 6 inputs/6 outputs.
- Compresses 12G-SDI to 3G/1.5G-SDI and processes 4K signals by using codec module USF-106TICO-12G simultaneously with input/output signals.
- Control: Web GUI, NMOS (IS-04/05 In-band).

※ Up to 3 USF-10IPSDI12-FS modules can be installed into USF-212BS.

Available modules

USF-106TICO-12G

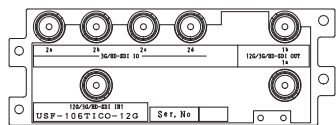

4K/TICO encoder/decoder

- TICO codec support enables video compression and expansion with high image quality and low latency.
- 4K video transfer over 3G/HD-SDI.
- One 12G-SDI input, 2 outputs.
- 4K 2SI/SQD, Level-A/B support.
- Downconversion from 4K to HD (1080i/1080p).
- Upconversion available as an option.
- HDR/WCG-compatible color processing.
- Audio processing enables automatic/semi-automatic audio delay setting.
- Frame synchronization.

Encoder

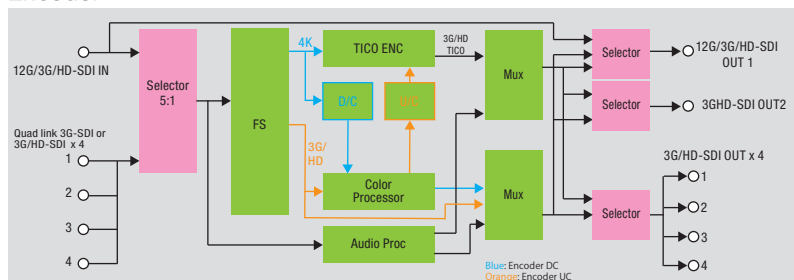

Decoder

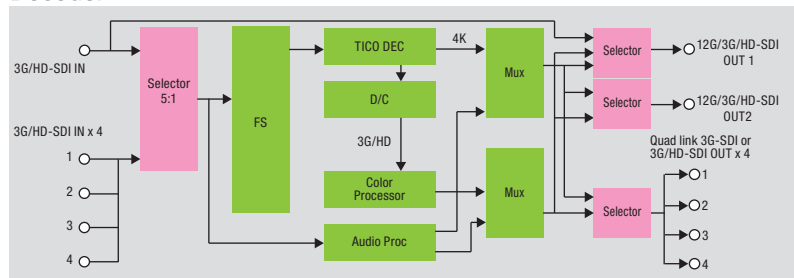

USF-1043FS

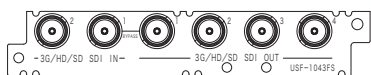

3G/HD/SD-SDI frame synchronizer

- Splits a 3G/HD/SD-SDI source selected from 2 inputs, for distributed output to 4 ports.
- FS mode: Adjusts phases and syncs asynchronous SDI signals to genlock signals.
- Automatic muting for detected audio errors.
- 16-channel audio sample rate converter (SRC).
- Audio delay adjustment for each channel (up to 1,000 ms), and audio channel remapping.
- Audio downmixing for linear PCM.
- Seamless switching of audio and video inputs.
- H/V ancillary data pass-through (synchronous input only).
- Proc amp, video clip, video delay, and freeze.
- 16-channel embedded audio support (asynchronous audio support for 3G/HD-SDI).
- SNMP monitoring.

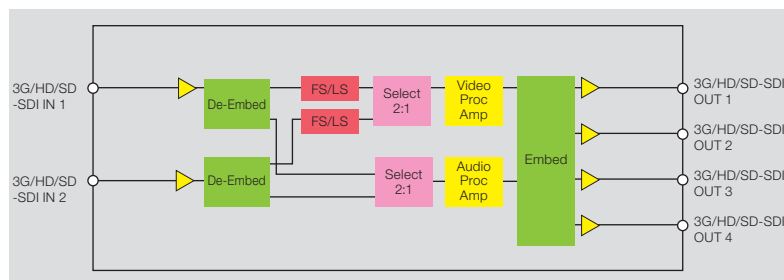

USF-105FS-12G

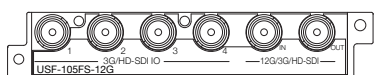

12G-SDI frame synchronizer

- Supports 3840 x 2160 Single Link 12G-SDI.
- Supports 3840 x 2160 Quad Link (SQD/2SI, Level-A/B) 3G-SDI (input and output are switched from a menu).
- 12G-SDI and Quad Link 3G-SDI (SQD/2SI, Level-A/B) conversion (Gearbox).
- FS mode: Adjusts phases and syncs asynchronous SDI signals to genlock signals.
- Automatic muting for detected audio errors.
- 16-channel audio sample rate converter (SRC).
- Audio delay adjustment for each channel (up to 1,000 ms), and audio channel remapping.
- Audio downmixing for linear PCM.
- H/V ancillary data pass-through (synchronous input only).
- Proc amp, video clip, video delay, and freeze.
- 16-channel embedded audio support (asynchronous audio support for 3G/HD-SDI).
- SNMP monitoring.

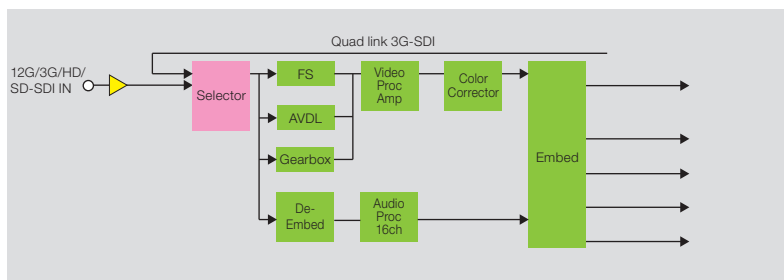

Available modules

USF-106UDC-12G

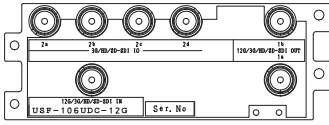

12G-SDI 4K/HD up/down converter

- Supports 3840x2160 Single Link 12G-SDI.
- Supports 3840x2160 Quad Link (2SI/SQD) 3G-SDI (input and output are switched from a menu).
- 3G-SDI Level-A/B conversion.
- Dynamic range conversion.
- Color processing circuit to support 4K/HD production.
- 16-channel embedded audio support.
- Sync modes: Frame, Line, AVDL, Line (Min.).
- GUI software (full) and web browser (limited) control.
- SNMP monitoring.

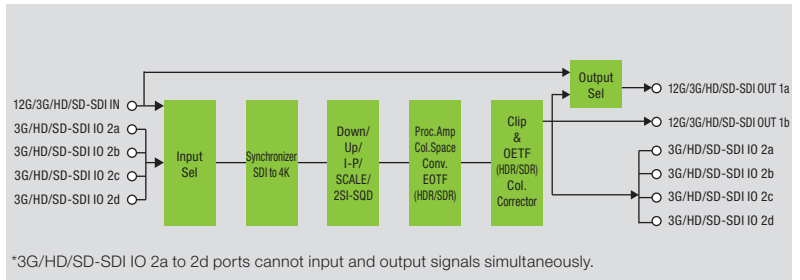

USF-106DC-12G

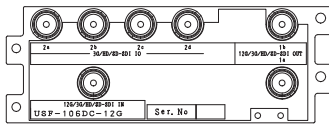

12G-SDI 4K to HD down converter

- Supports 3840x2160 Single Link 12G-SDI.
- Supports 3840x2160 Quad Link (2SI/SQD) 3G-SDI (input and output are switched from a menu).
- Dynamic range conversion.
- Color processing circuit to support 4K/HD production.
- 16-channel embedded audio support.
- Sync modes: Frame, Line, AVDL, Line (Min.).
- GUI software (full) and web browser (limited) control.
- SNMP monitoring.

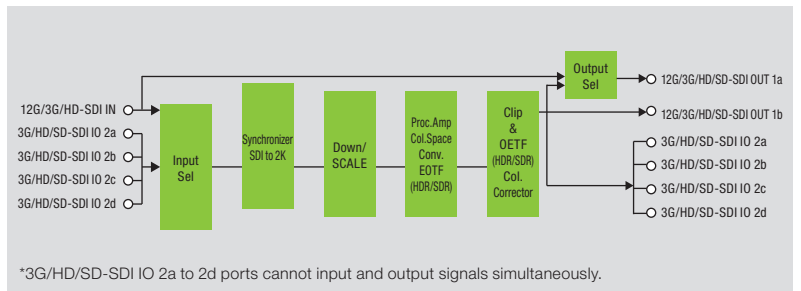

USF-111DDA-12G

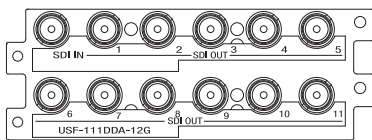

12G-SDI 11 outputs digital video distributor

- Supports SDI 12 Gbps, 3 Gbps, 1.5 Gbps, or 270 Mbps signals.
- DVB-ASI (270 Mbps) also supported.
- SNMP monitoring.
- Equalizer and re-clock functions.

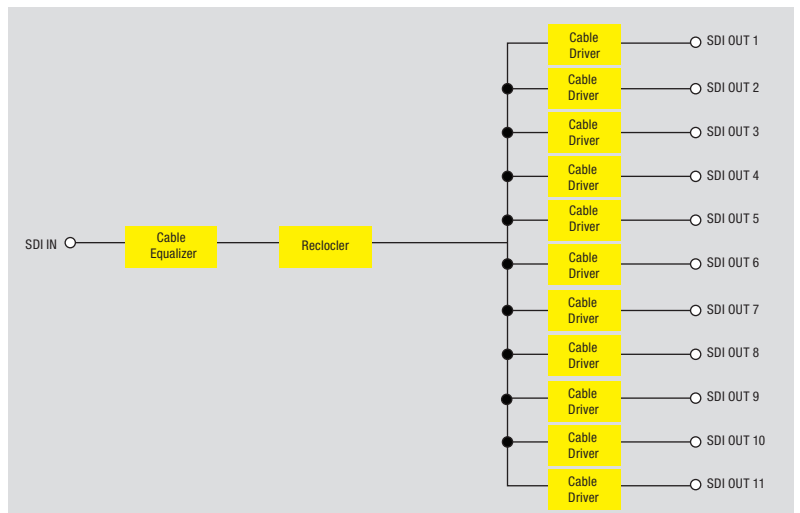

Available modules

USF-105DDA-12G

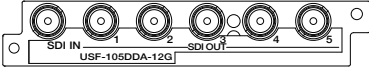

12G-SDI 5 outputs digital video distributor

- Supports SDI 12 Gbps, 3 Gbps, 1.5 Gbps, or 270 Mbps signals.
- DVB-ASI (270 Mbps) also supported.
- SNMP monitoring.
- Equalizer and re-clock functions.

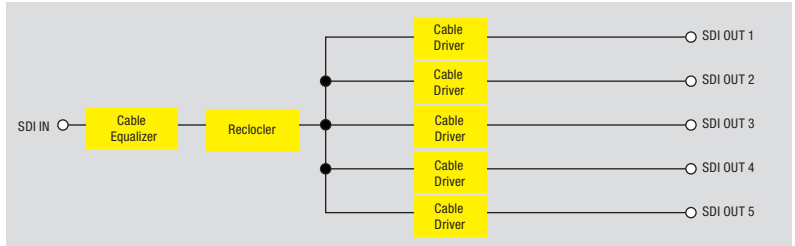

USF-1053DDA

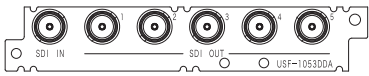

5 outputs 3G/1.5G/270 Mbps digital video distributor

- 1 input 10 distribution outputs available with 2 USF-1053DDA modules.
- 3G/HD/SD-SDI equalization and reclocking.
- Supports SDI 3.0 Gbps, 1.5 Gbps, or 270 Mbps signals.
- DVB-ASI (270 Mbps) also supported.
- SNMP monitoring.

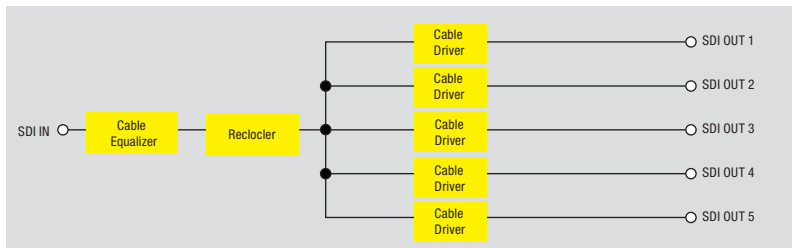

USF-1043VM

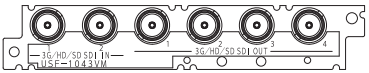

3G/HD/SD-SDI digital video distributor with signal monitor and change-over switch

- Supports 3G/HD/SD-SDI signals.
- Can be configured for 1 input/4 outputs or 2 inputs/2 outputs systems.
- Switches seamlessly to the other line when errors of input signals are detected.
- SNMP monitoring.

* 2 of the input signal must be the same format.

2 inputs/2 outputs mode

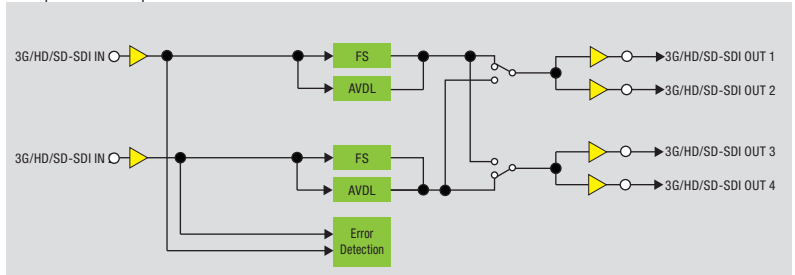

1 input/4 outputs mode

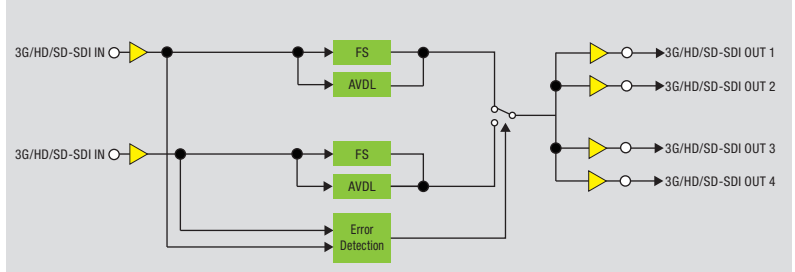

Available modules

USF-1100VEA

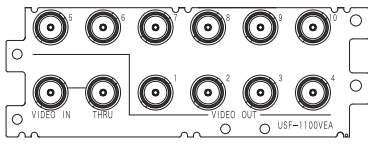

10 outputs analog video distributor

- Cable equalization corrects frequency characteristics in analog video distribution.
- Ideal for BB or tri-level sync signal distribution.
- Pass-through input supported.
- Browser-based control and SNMP monitoring (optional).

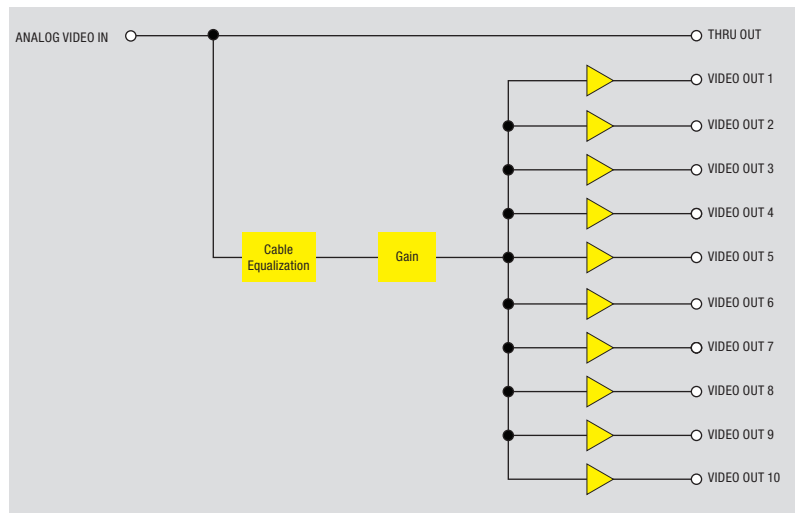

USF-1040VEA



4 outputs analog video distributor

- Cable equalization corrects frequency characteristics in analog video distribution.
- Ideal for BB or tri-level sync signal distribution.
- Pass-through input supported.
- Browser-based control and SNMP monitoring (optional).

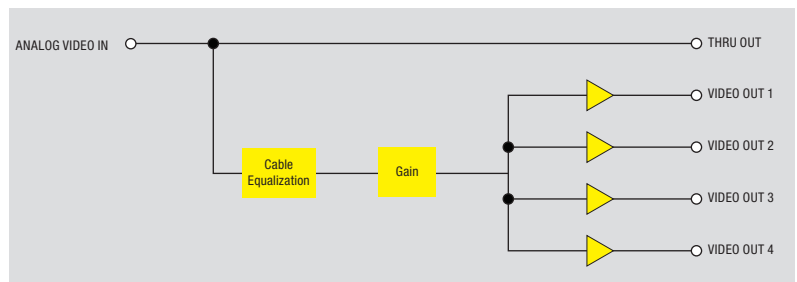

USF-105DADA



5 outputs unbalanced digital audio distributor

- Expandable to 20 outputs, using 4 modules.
- LTS and Word Clock signals can be supported by changing the signal mode.
- SNMP monitoring.

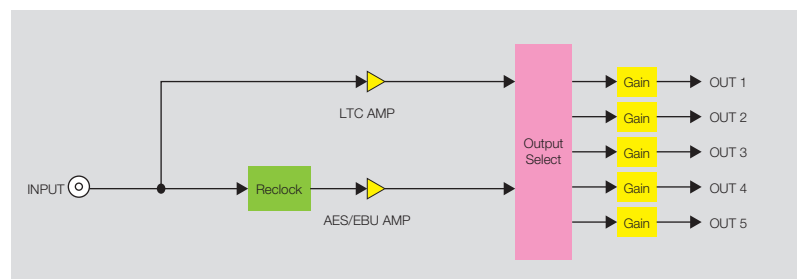

Available modules

USF-108ADA

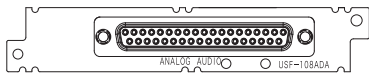

8 outputs analog audio distributor

- Can be configured for single channel mode or dual channel mode.
- Browser-based control and SNMP monitoring (optional).

Single channel mode (1-input x 8-distribution)

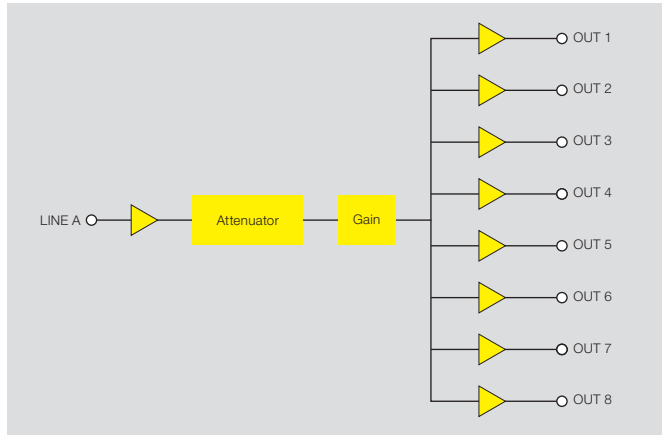

Dual channel mode (2-channels x 4-distribution)

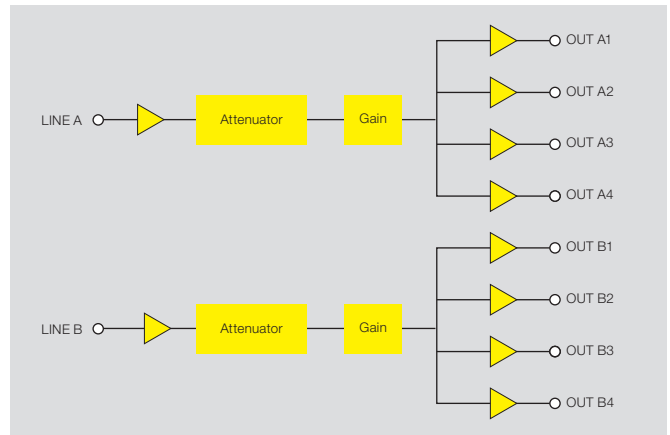

USF-204ADAC

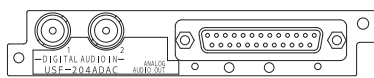

Digital-to-analog audio converter with AES/EBU 2 channels input

- Converts 2 channels of digital audio to 4 channels of analog audio.
- Adjustable digital audio input level (-20/-18 dBFS).
- Adjustable audio output level (-10/0/4/8 dBu).
- Adjustable audio silence period (1 to 10 sec).
- SNMP monitoring.

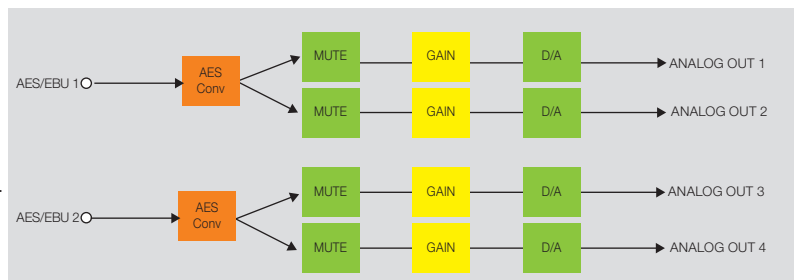

USF-402AADC

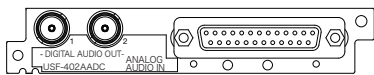

Analog-to-digital audio converter

- Converts 4 channels of analog audio to 2 channels of digital audio.
- Adjustable input impedance (600Ω/high).
- Adjustable input gain (±6 dB with front dial, ±20 dB via browser).
- Adjustable analog audio input level (-10/0/4/8 dBu).
- Adjustable digital audio reference level (-18/-20 dBFS).
- Adjustable audio silence period (1 to 10 sec).
- Supports output synced with reference signals from the USF.
- SNMP monitoring.

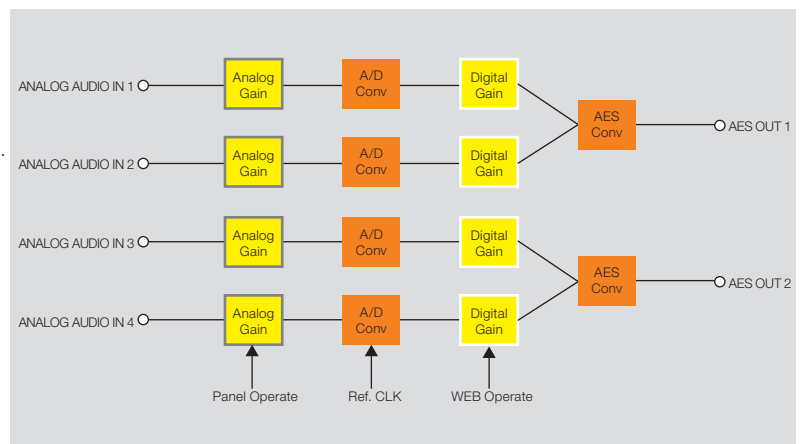

Available modules

USF-101MDX4-12G

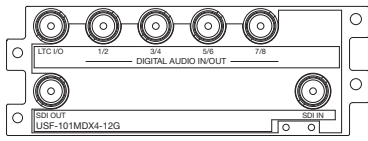

12G-SDI 4K audio multiplexer/demultiplexer with 8 channels of AES/EBU input/output

- Supports transfer rates from 1.5 Gbps to 12 Gbps.
- Sync modes: Frame, Line, AVDL, Line (Min.).
- Sample rate converter (SRC) for MUX/DEMUX of asynchronous AES/EBU signals (switched from a menu).
- MUX: Mapping 8 channels (4 pairs) of AES/EBU signals in 16 channels and embedding onto SDI signals
- DEMUX: De-multiplexes 8 selected channels from 16 channels from SDI signals as AES/EBU audio output.
- LTC port is used for input and output.
- SNMP monitoring.

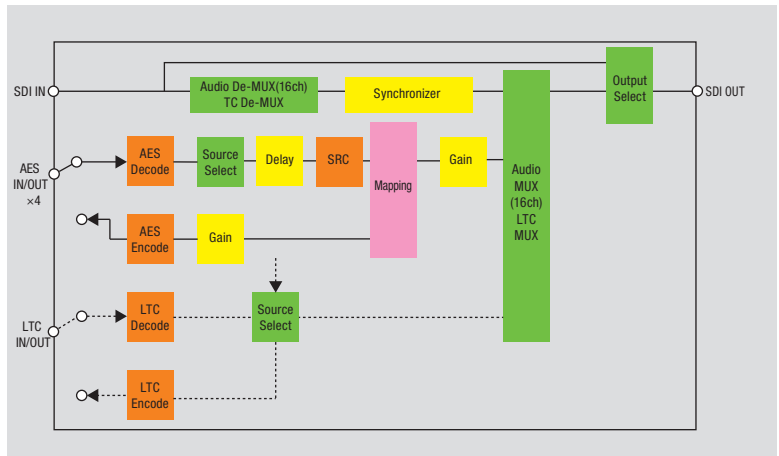

USF-101MDX8-12G

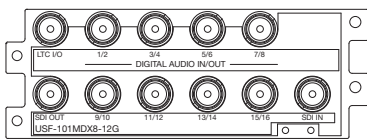

12G-SDI 4K audio multiplexer/demultiplexer with 16 channels of AES/EBU input/output

- Supports transfer rates from 1.5 Gbps to 12 Gbps.
- Sync modes: Frame, Line, AVDL, Line (Min.).
- Sample rate converter (SRC) for MUX/DEMUX of asynchronous AES/EBU signals (switched from a menu).
- MUX: Mapping 16 channels (8 pairs) of AES/EBU signals in 16 channels and embedding onto SDI signals.
- DEMUX: De-multiplexes 8 selected channels from 16 channels from SDI signals as AES/EBU audio output.
- LTC port is used for input and output.
- SNMP monitoring.

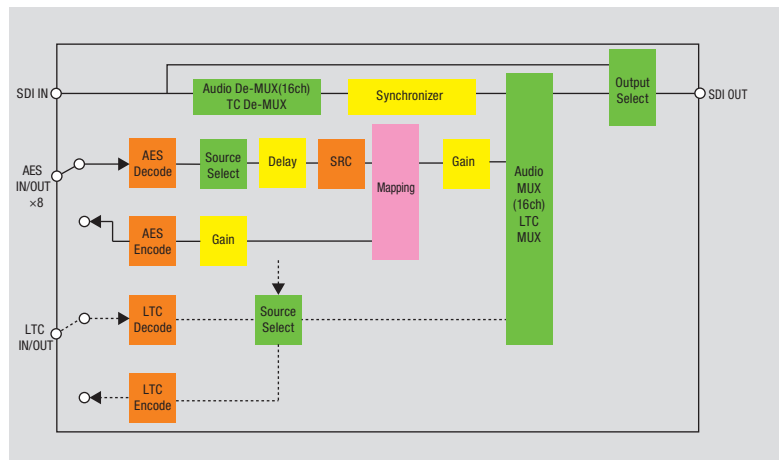

Available modules

USF-1013MUX



3G/HD/SD-SDI digital audio multiplexer

- Multiplexes 4 pairs (8 channels) of AES/EBU signals onto SDI signals.
- 1 input and 1 output (3G/HD/SD-SDI).
- Gain adjustment for audio input/output.
- Timecode (LTC) input (or AES IN 7/8 available).
- Sample rate converter for AES/EBU input.
- SNMP monitoring.

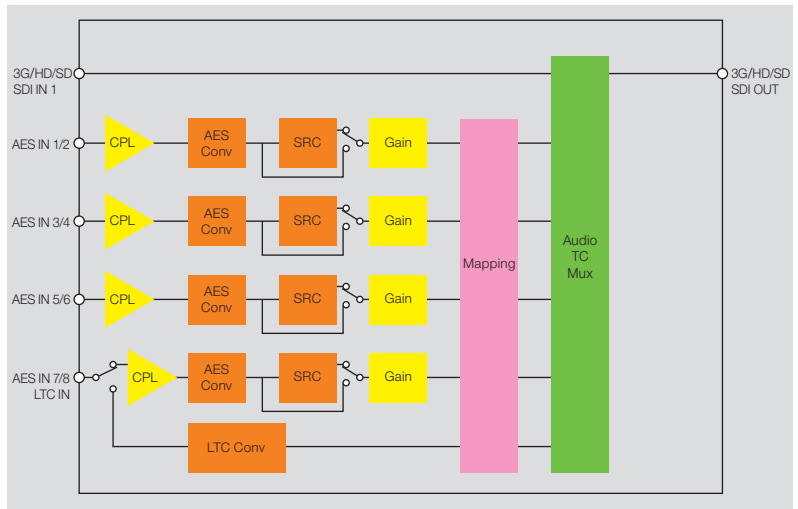

USF-1013DEMUX



3G/HD/SD-SDI digital audio demultiplexer

- De-multiplexes audio from SDI signals into AES/EBU audio output.
- 1 input and 1 output (3G/HD/SD-SDI).
- Gain adjustment for audio input/output.
- Timecode (LTC) input (or AES IN 7/8 available).
- SNMP monitoring.

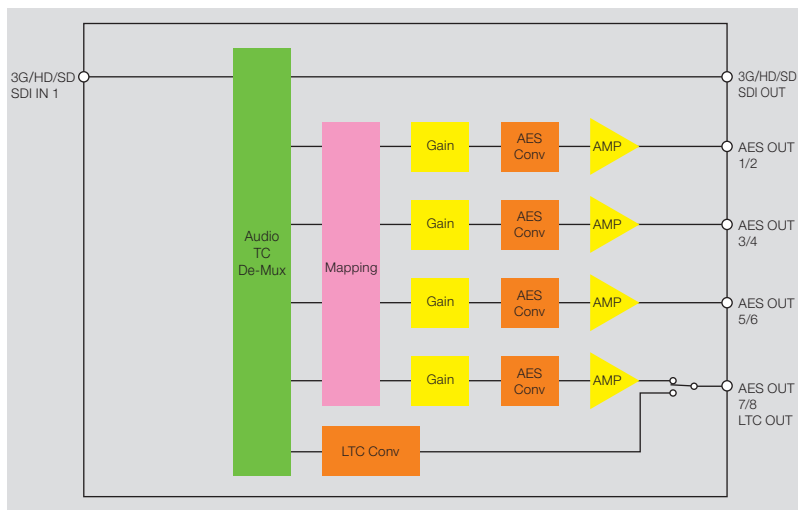

Available modules

USF-80SDICS

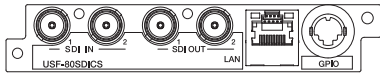

1 Modular SDI Changeover Switcher

Monitors status of two SDI inputs and seamlessly switches to the normal line in case of errors

- Supports multiple bit rate 3G-SDI (Level-A/B) and HD/SD signals.
- Auto-switching, auto-switching/manual return and manual switching.
- Detects CRC errors, sync loss, image freezing, black video, audio muting, and other errors.
- Corrects delay between inputs.
 - Auto correction using image comparison, LTC, or VITC.
 - Manual correction setting range: 1–21 frames.
- Frame synchronization.
 - Delay correction and seamless switching even between asynchronous input.
 - External sync locking.
- Signal bypass output.
 - Passthrough makes signal output available when offline.
- Configure settings and monitor input signal via dedicated GUI.

※ Module status checking from USF frame is not supported. GUI-based control and monitoring is performed via the LAN port of this module.

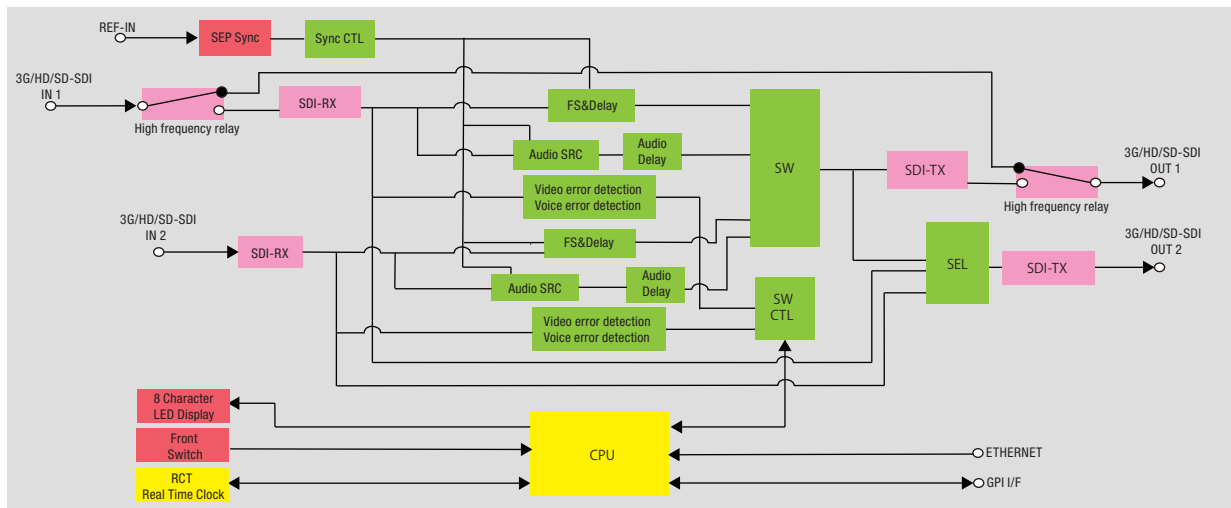

USF-105AS/105PS Datasheet

1. Specifications

USF-105AS Basic specifications

Temperature	0°C to 40°C
Humidity	30% to 90% (no condensation)
Power	100 to 240 V AC 50/60Hz
Consumption	119 VA (at 100 to 120 V AC at maximum output current) 125 VA (at 220 to 240 V AC at maximum output current)
Maximum Output Current	+12V DC 8.3 A
Dimensions	436 (W) x 44 (H) x 403 (D) mm 480 (W) (Including rack mount brackets)
Weight	5.6 kg (USF-105PS not included)
Consumables (at 24-hour operation)	Power supply unit: Replace every 5 years Cooling fan: Replace every 6 years

USF-105AS Technical specifications

Number of Modules	Max. 5
Genlock Input	BB: 0.429 Vp-p (NTSC)/PAL: 0.45 Vp-p, Tri-level sync: 0.6 Vp-p 1 input: 75Ω BNC x 1 and Loop-through BNC x 1 for each (Terminate with 75Ω terminator, if unused.)
Interface	
Ethernet	100BASE-TX / 1000BASE-T RJ-45 x 1 (LAN 1) 100BASE-TX RJ-45 x 1 (LAN A)
GPI	9-pin D-sub (female) x 1 (inch screw)

Options

USF-105PS	Redundant Power Supply Unit
-----------	-----------------------------

Accessories

AC cord, DVD-ROM, Air duct unit, and Setup guide

USF-105PS Basic specifications

Temperature	0°C to 40°C
Humidity	30% to 90% (no condensation)
Power	100 to 240 V AC 50/60Hz
Maximum Output Current	+12V DC 8.3 A
Dimensions	52 (W) x 40 (H) x 261.5 (D)mm
Weight	0.4 kg

2. External Dimensions

USF-105AS

(All dimensions in mm.)

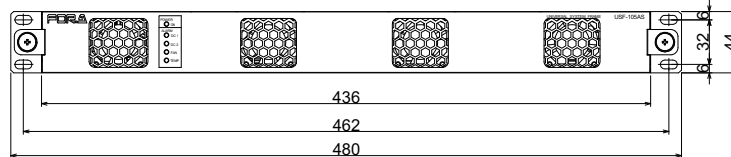
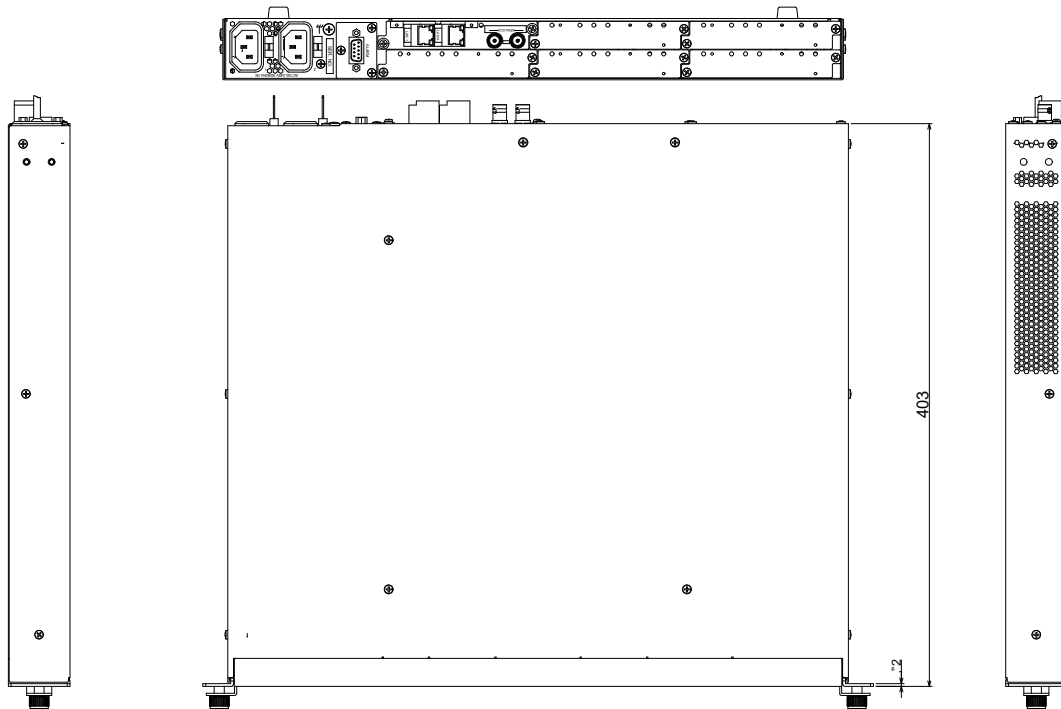

USF-105PS

(All dimensions in mm.)

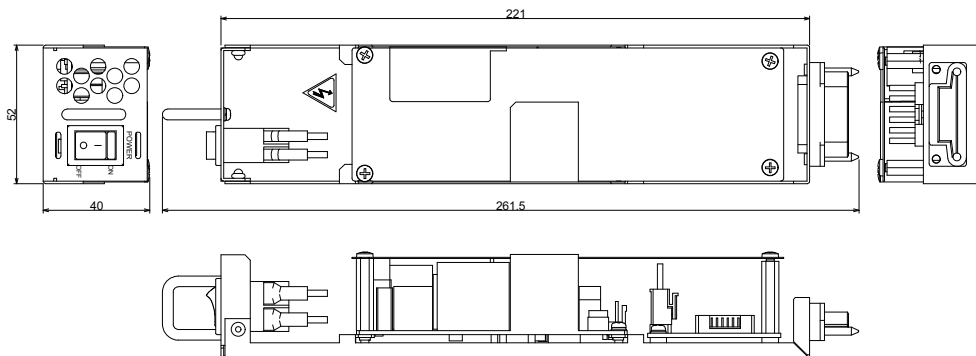

USF-212BS / USF-212PS Datasheet

1. Specifications

USF-212BS Basic specifications

Temperature	0°C to 40°C
Humidity	30% to 90% (no condensation)
Power	100 to 240 V AC \pm 10%, 50/60 Hz
Power Consumption	670 VA (at 100 to 120 V AC at maximum output current) 660 VA (at 220 to 240 V AC at maximum output current)
Dimensions	440 (W) x 88 (H) x 400 (D) mm 480 (W) (Including rack mount brackets)
Weight	9.7 kg (Including 1 unit of power supply)
Consumables (at 24-hour operation)	Power unit: Within 5 years Cooling fan (P-1620): Within 6 years

USF-212BS Technical specifications

Number of Modules	Max. 12
Genlock Input	BB: 0.429 Vp-p (NTSC)/0.45 Vp-p (PAL) or Tri-level Sync: 0.6 Vp-p 75 Ω BNC x 2 (W/ loop-through per each. Terminate with 75-ohm, if unused.)
Interface	
Ethernet	100BASE-TX / 1000BASE-T RJ-45 x 2 (LAN 1, LAN 2) 100BASE-TX RJ-45 x 1 (LAN A)
Alarm	9-pin D-sub Female

Option

USF-212PS	Redundant Power Supply Unit AC cord included
-----------	---

Accessories

AC cord, DVD-ROM, and Quick setup guide

USF-212PS Basic specifications

Temperature	0°C to 40°C
Humidity	30% to 90% (no condensation)
Power	100 to 240 V AC \pm 10%, 50/60 Hz
Power Consumption	670 VA (at 100 to 120 V AC at maximum output current) 660 VA (at 220 to 240 V AC at maximum output current)
Maximum Output Current	+12 V DC 58.4 A
Dimensions	68.6 (W) x 41.3 (H) x 397 (D)mm
Weight	1.6 kg

2. External Dimensions

(All dimensions in mm.)

USF-212BS

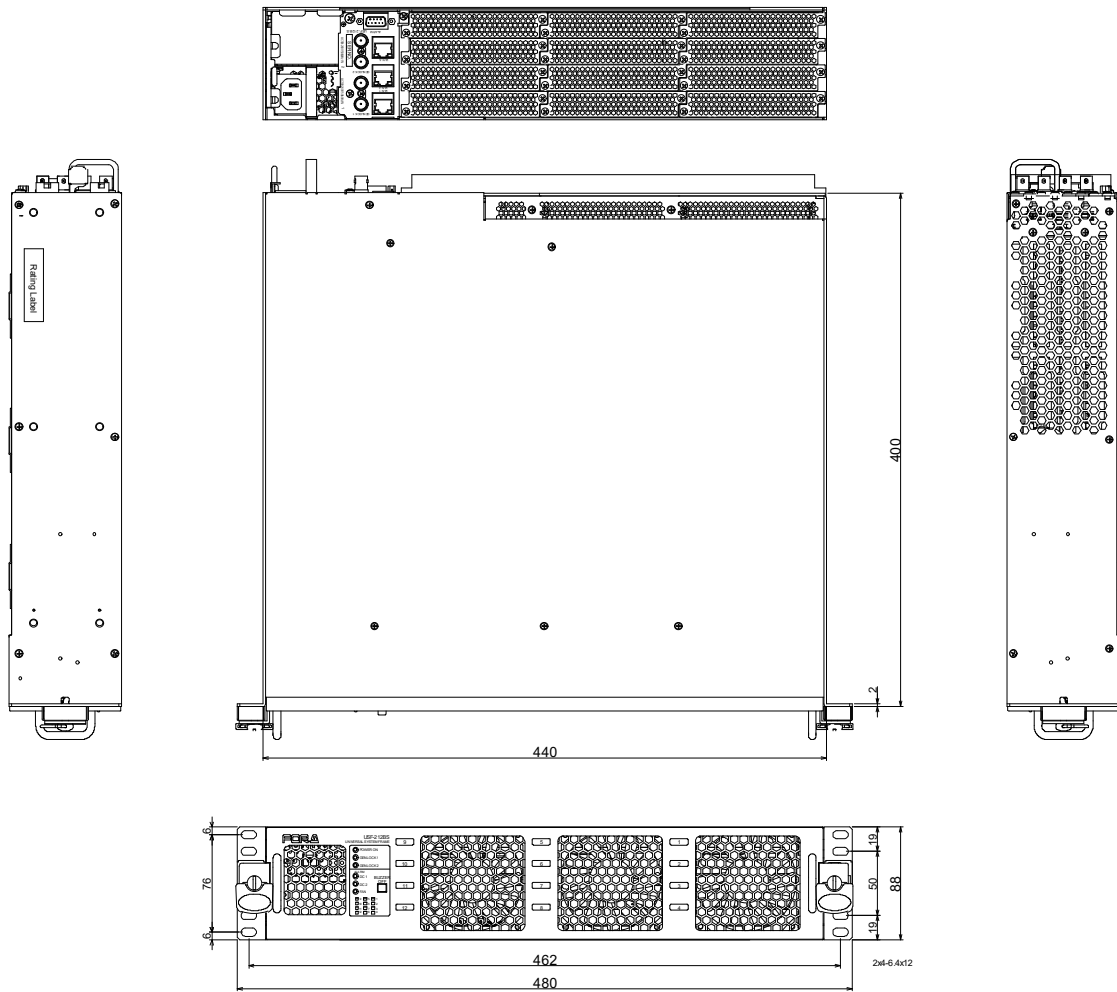

USF-212PS

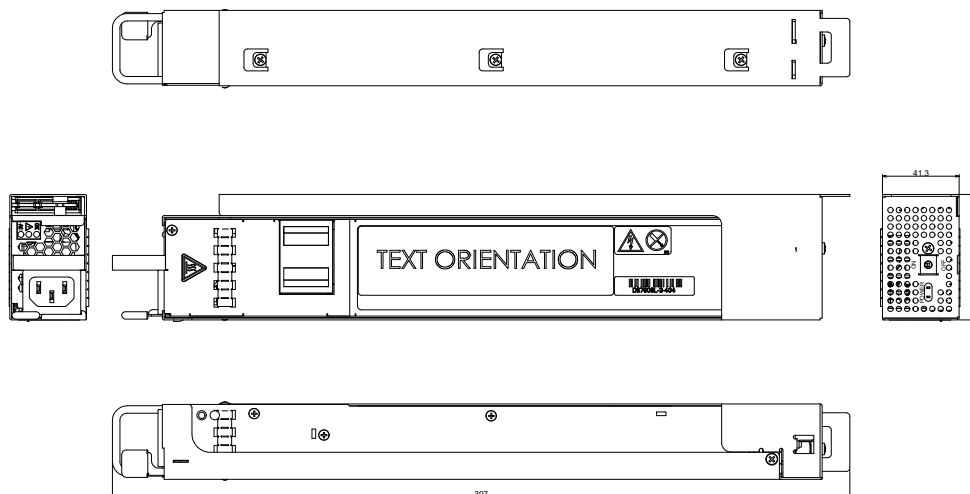



FOR-A COMPANY LIMITED www.for-a.com

ISO 9001 and 14001 certified
(Sakura R&D)

Head Office:

3-8-1 Ebisu, Shibuya-ku, Tokyo 150-0013, Japan
Tel: +81 (0)3-3446-3936

FOR-A Corporation of America Corporate Office/Service Center:

11155 Knott Ave., Suite G, H & I, Cypress, CA 90630, U.S.A.
Tel: +1 714-894-3311

FOR-A Corporation of America Northeast Office:

Tel: +1 973-220-8471

FOR-A Corporation of America Southeast Office:

Tel: +1 305-773-7608

FOR-A Corporation of America Support Center:

2400 N.E. Waldo Road, Gainesville, FL 32609, U.S.A.
Tel: +1 352-262-5779

FOR-A Latin America and the Caribbean Miami Office:

Tel: +1 657-600-5759

FOR-A Latin America and the Caribbean Sao Paulo Office:

Tel: +55 11-99913-3751

FOR-A Latin America and the Caribbean Mexico City Office:

Tel: +52-55-5072-4969

FOR-A Europe S.r.l.:

Via Volturmo, 37, 20861 Brugherio MB, Italy
Tel: +39 (0)39-916-4811

FOR-A UK Limited:

Trident Court, 1 Oakcroft Road, Chessington, KT9 1BD, UK
Tel: +44 (0)20-3044-2935

FOR-A Italia S.r.l.:

Via Volturmo, 37, 20861, Brugherio MB, Italy
Tel: +39 (0)39-881-086

FOR-A Corporation of Korea:

1007, 57-5, Yangsan-ro, Yeongdeungpo-gu, Seoul 07271, Korea
Tel: +82 (0)2-2637-0761

FOR-A China Limited:

1618A Huateng Building, No. 302, 3 District, Jinsong, Chaoyang,
Beijing 100021, China
Tel: +86 (0)10-8721-6023

FOR-A Middle East-Africa Office:

DSC Tower, Office 207, Dubai Studio City,
P.O. Box 502688, Dubai, UAE
Tel: +971 (0)4-551-5830

FOR-A India Private Limited Corporate Office:

Unit No: 800, World Trade Tower, Sector-16, Noida-201301, Uttar
Pradesh, India
Tel: +91-120-4238674 / +91-120-4252330

FOR-A India Private Limited Mumbai Office:

202-203, Wellington Business Park No-01, Marol, Off, Andheri Kurla
Road, Andheri East, Mumbai-400059, Maharashtra, India
Tel: +91 22-49795570

FOR-A South East Asia Hong Kong Office:

Studio 09, Rm. A1, 3/F., Phase 1, Hang Fung Ind. Bldg., 2G Hok
Yuen St., Hung Hom, Hong Kong
Tel: +852-2110-9227

FOR-A South East Asia Singapore Office:

Tel: +65-8686-8086