

# FA-10RU

## Quick Setup Guide

**Packing list:**  
 FA-10RU (1), Quick Setup Guide (1), CD (including Operation Manuals),  
 AC cord (1), AC cord retaining clip (1 set), Rack mount bracket set (1 set),  
 Colored light identification label

FA-10RU units are remote controllers for **FA-505, FA-1010, FA-9600, USF-106UDC/DC-12G** and **USF-1043FS** (Main Unit, hereafter called **MU**) and control MUs via LAN. One MU unit can be controlled by up to **5** remote controllers (multiple FA-10RU, FA-10DCRU and/or Windows GUI software).

Check your received items against the packing lists. Check to ensure no damage has occurred during shipment. If damage has occurred, or items are missing, inform your supplier immediately.



### 1. Rear Connectors

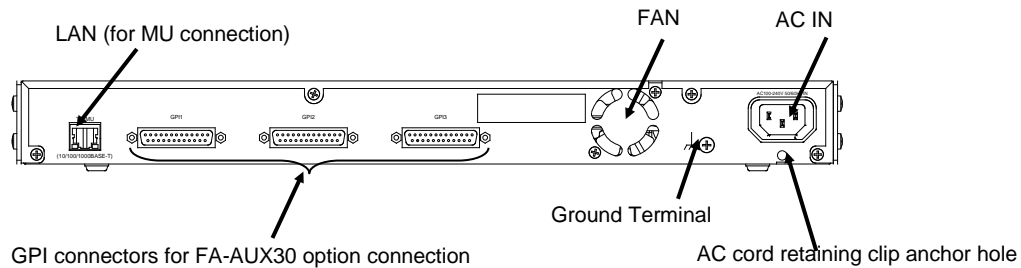

### 2. Installing the AC Cord Retaining Clip

After connecting the AC cord, secure the AC cord with the supplied ladder strap/retaining clip assembly to prevent accidental removal from the MU. Be sure to install the AC cord retaining clip before mounting the unit into a rack.

- 1) Wrap the retaining clip around the AC cord (with the anchor of the ladder strap toward the unit).
- 2) Insert the anchor into the hole above the AC IN socket.
- 3) Lightly fasten the clip around the AC cord.
- 4) Plug in the power cord.
- 5) Slide the clip on the ladder strap toward the plug.
- 6) Fasten the clip tightly.
- 7) Gently pull on the AC cord to ensure it is secured.

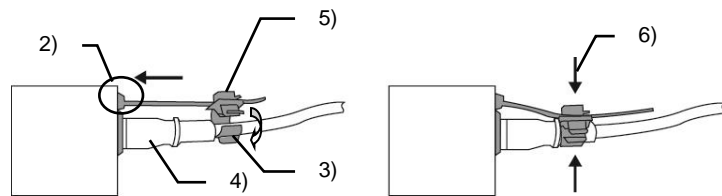

Make sure that the LOCK button LED on the front panel is lit green or unlit before starting an operation. If LOCK button LED is lit orange, all operations on the front panel except the LOCK button are disabled. Press and hold the LOCK button to unlock the operations.

\* Complete connections before turning the power of the unit on.

#### Precautions

- Operate the unit **only** at the specified supply voltage.
- **Ensure** the unit is properly grounded at all times.
- **Ensure** the power cord and connectors are firmly connected.
- **Do not** access circuitry with power applied to the unit.
- Unit **should not** be operated or stored with the cover, panels, and/or casing removed.
- Unit **should not** be operated or stored in a humid, dusty, etc. environment. Doing so could result in fire or electrical shock.
- **Do not** allow fluids, metal fragments, or any other foreign objects to enter the unit. If foreign matter does enter the unit, turn the power off and disconnect the power cord immediately. Remove the material or contact your authorized service representative
- If you notice any strange smells or noises coming from the unit, turn the power off immediately, turn OFF the power switch, disconnect the power cord, then contact your authorized service representative.

### 3. Connection (in case of FA-1010)

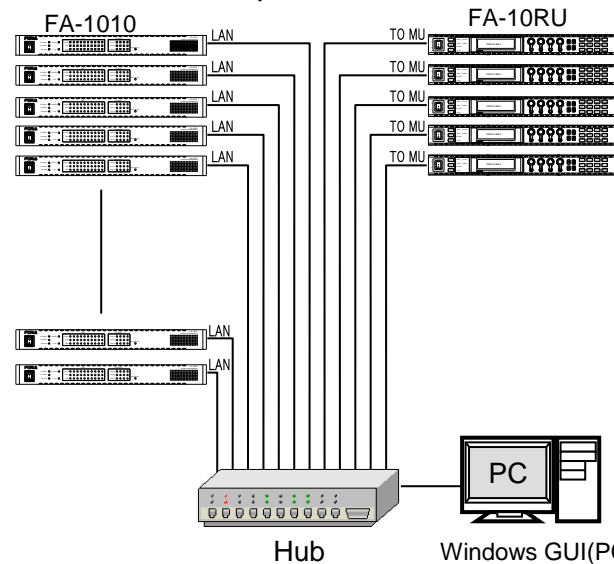

Open a web browser on the connected computer, and enter the address <http://192.168.0.100/> (factory default setting) in the address bar. The authentication dialog box (the first time only) and Information page as shown below appear.

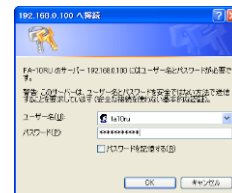

Enter your user name and password.

**User name:** fa10ru  
**Password:** foranetwork  
 Then, click **OK**.

Click **Network Settings** in the Information page.

Set an appropriate IP address for your network. After completing the settings, click **Submit**, and then click **Restart**. The Restart window appears. Click **Restart** in the window. The settings take effect after the restart is completed.

#### Assigning MUs

Click **Unit ID Assignment** to open the dialog box as shown below.

Enter FA-1010 IP addresses to MU IDs. Enter unit names to be displayed for settings, if necessary, under Unit Name. After assigning IP addresses, click **Submit**. (The assignments are effective without rebooting.) Unit names can be set with up to 15 alphanumeric characters.

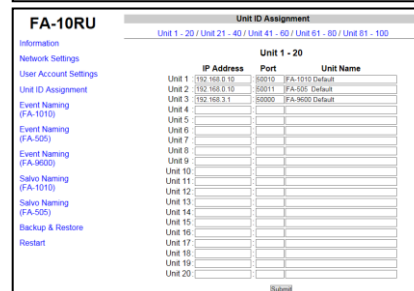
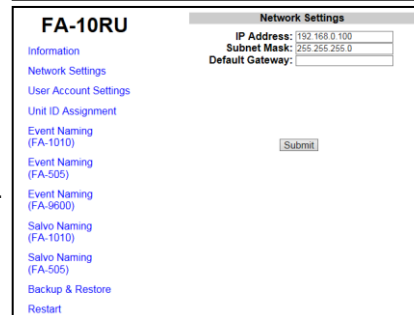
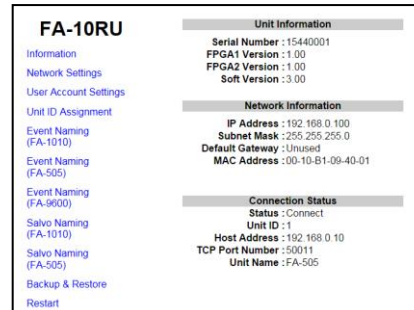

### 4. Powering ON

Turn the power ON after all system connections are complete. The indicators on the front panel light up during startup. When startup is complete, the indicators will go off. The "UNIT ID MU SELECT" menu will appear if no MU unit is connected.

### 5. Connecting MU

There are two ways to connect to the MU; one is in Unit ID Selection mode, which allows you to connect an MU by selecting an ID from among 100 ID numbers, and the other is in IP Address Selection mode, which allows you to connect an MU by specifying an IP address.

#### Connecting in Unit ID Selection Mode

Pressing the MU SEL button opens the UNIT ID MU SELECT menu.

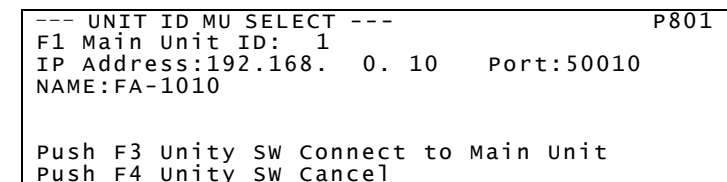

Turn F1 and select the MU to be connected from Main Unit IDs **1 through 100**. The IP address, TCP port number, and unit name will be displayed for the selected Main Unit ID. Press the **UNITY button under F3 (SET)** to establish a connection with the MU. The MU CONNECT STATE menu appears when connection is initiated.

To cancel the selection, press the UNITY button under F4 (CANCEL). Cancelling the connection returns the settings to their last state before change. To quit the connection, select **Disconnect** using F1 and press the UNITY button under F3. (The connected MU will also be disconnected.)

#### Connecting in IP Address Selection Mode

Press the MU SEL button. The UNIT ID SEL menu appears. Then, press the double down-arrow button. The IP ADDRESS MU SELECT menu appears.

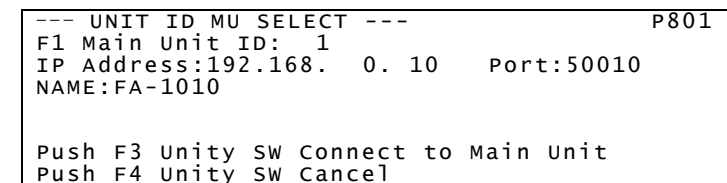

Enter the **IP address** of the MU to be connected using control knobs F1 to F4. Go to the second line to specify the MU **TCP port number** using F1 and F2 (F1 and F2 can change the number in 100's and 1's increments respectively.) Press the **UNITY button under F3** to establish connection with the MU. The MU CONNECT STATE menu will then appear.

To cancel the selection, press the UNITY button under F4 (CANCEL). Cancelling the connection returns the settings to their last state before change.

## 6. Connecting to an FA-AUX30

Connect GPI connectors on the FA-10RU and FA-AUX30 using cables supplied with the FA-AUX30.

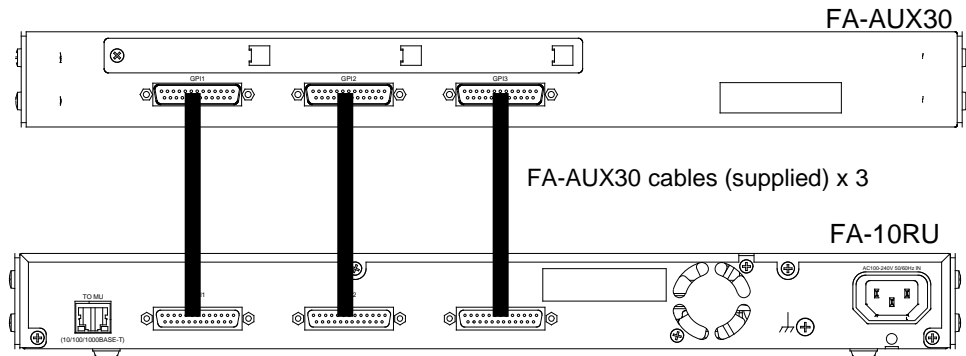

## 7. Assigning Functions to FA-AUX30 Buttons Using Preset Assignment Patterns

No functions are pre-assigned to buttons 1 through 30 at shipment. Preset patterns allow you to assign functions to buttons 1 through 30 simultaneously. Press the MU SELECT button on the FA-10RU front panel, then press 10 SYSTEM (while the button is lit red) to open the LOAD GPI PATTERN menu.

```

--- LOAD GPI PATTERN --- P821
F1 GPI1 BLOCK:None
F2 GPI2 BLOCK:None
F3 GPI3 BLOCK:None
Press F4 UNITY to start pattern loading
    
```

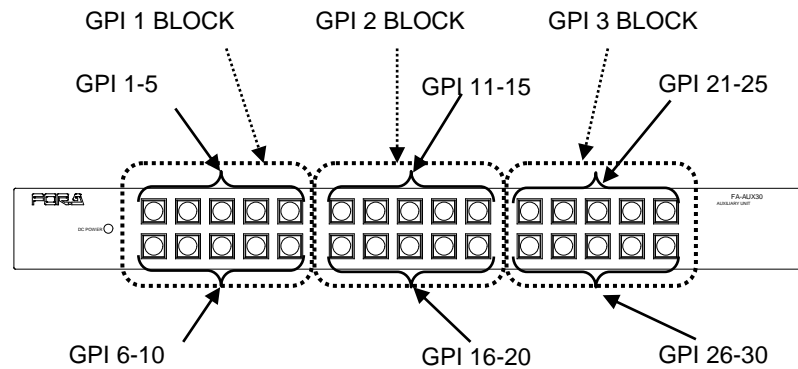

Functions can be assigned in 10 button-units under GPI 1 BLOCK, GPI 2 BLOCK, and GPI 3 BLOCK by selecting patterns using corresponding control knobs F1 to F3. Press the F4 UNITY button to load the selected pattern.

### ◆ Preset Patterns

The following 33 patterns are available.

Select "----" not to change. Select "None" for no function.

---	Clean SW (Salvo1-10 Load)
None	Clean SW (Salvo1-10 Save)
MU Select	Clean SW (Salvo1-5 Load/Save)
FS Select	Time Code Generator
Process(FS1-FS10)	Freeze(FS1-FS10)
Video Level(FS1-FS10)	Audio Gain(FS1-FS10)
Chroma Level(FS1-FS10)	Audio Delay(FS1-FS10)
Setup/Black(FS1-FS10)	Event(No1-10 Load)
Hue(FS1-FS10)	Event(No1-10 Save)
CC (FS1-FS10)	Event(No1-5 Load/Save)
CC White(FS1-FS10)	Menu1 Select
CC Black(FS1-FS10)	Menu2 Select
CC Gamma(FS1-FS10)	Menu3 Select
BY-PASS(SDI1-SDI10)	Menu4 Select
Clean SW (Destination)	Status1
Clean SW (Source)	Status2
Clean SW (Mode/Take)	

## 8. Customizing Button Functions

Proceed to the next page (P822) from LOAD GPI PATTERN using the double down-arrow button to customize functions for each button.

- Turn F1 and select a port number from GPI 1 through 30.

```

--- GPI INPUT PORT FUNCTION --- P822
F1 Port:GPI1 PORT 1(FA-AUX30 Right Block)
Setting1:None
Setting2:None
Setting3:None
Setting4:None
    
```

- Press the down-arrow button for F1, F2, F3 and F4 to be displayed to the left of Setting 1 – 4. Turn the corresponding control knob F1 - F4 and select functions. Selecting a function under Setting 1 enables corresponding settings under Setting 2 – 4. Selectable settings under Setting 1 and their corresponding settings are shown in the table to the right.
- Pressing the up-arrow button enables you to select the next port to set settings. Set functions for each port by repeating steps 1 and 2.

### ◆ Assigning Indication Functions to Buttons

Status indications such as input signal or alarm status can be assigned to each button LED.

See the FA-10RU Operation Manual, section 9-1-3. "GPI OUTPUT PORT FUNCTION" for further details.

### ◆ Corresponding settings (Shaded settings unavailable for FA-9600.)

No	Setting1	Setting2	Setting3	Setting4
1	None	---	---	---
2	MU Select	Menu Disconnected ID1-ID100	None, FS1, FS2 FS3-FS10	---
3	FS Select	FS1, FS2 FS3-FS10	---	---
4	Video Process	Video Process Amplifier Video Level Chroma Level Setup/Black level Hue	Menu, FS1, FS2 FS3-FS10	---
5	Color Corrector	Color Correction White Level Black Level Gamma Level	Menu, FS1, FS2 FS3-FS10	---
6	Freeze (Mode)	Menu Frame Odd Even	None, FS1, FS2 FS3-FS10	None Menu
7	Freeze (On/Off)	On Off On/Off	None, All, FS1, FS2 FS3-FS10	None Menu
8	By-pass	Menu On Off On/Off	All, FS1, FS2 FS3-FS10	None Menu
9	Audio Gain (Embedded)	Menu, FS1, FS2 FS3-FS10	---	---
10	Audio Gain (AES)	Menu, Option Slot A-D	---	---
11	Audio Gain (Analog)	---	---	---
12	Audio Delay (Embedded)	Menu, FS1-FS10	---	---
13	Audio Delay (AES)			
14	Audio Delay (Analog)			
15	Time Code	Menu Start Stop Reset Preset	None, Menu	None FS1 LTC FS1 VITC FS1 LTC & VITC FS2 LTC FS2 VITC FS2 LTC & VITC
16	Clean Switch			
17	Video Test Signal	Menu Video Test Signal (Off) Video Test Signal (100% CB) Video Test Signal (75% CB) Video Test Signal (SMPTE CB) Video Test Signal (RAMP)	All, FS1, FS2 FS3-FS10	On On/Off On (with Menu Move) On/Off (with Menu Move)
18	Audio Test Signal (Embedded)	Menu Audio Test Signal (Off) Audio Test Signal (500Hz) Audio Test Signal (1kHz)	FS1, FS2 FS3-FS10	On On/Off On (with Menu Move) On/Off (with Menu Move)
19	Audio Test Signal (AES)			
20	Audio Test Signal (Analog)			
21	All Audio Test			
22	GPI Lock	On, Off, On/Off	---	---
23	Memory Load	Event, Salvo	Menu, Default, No1-100	FA-10RU, MU
24	Memory Save	Event, Salvo	Menu, No1-100	FA-10RU, MU
25	Menu Move	P000-P1499	None, FS1, FS2 FS3-FS10	None, Line1-Line8
26	Color Corrector Split	Off, Mode1-3	None, FS1, FS2 FS3-FS10	None, Menu
27	DRC Operate	On, Off, On/Off	None, FS1, FS2	None, Menu
28	Input Color Space	Rec. ITUR BT.709 Rec. ITUR BT.2020 User1-5	None, FS1, FS2 FS3-FS5	None, Menu
29	Output Color Space	Rec. ITUR BT.709 Rec. ITUR BT.2020 User1-5	None, FS1, FS2 FS3-FS5	None, Menu
30	Input Gamma (EOTF) *2	Pattern1-13 *1 Pattern 0	None, FS1, FS2 FS3-FS5	None, Menu
31	Output Gamma (OETF)	Pattern1-13 *1 Pattern 0	None, FS1, FS2 FS3-FS5	None, Menu

The above table is the GPI input pin function setting list. An "----" indicates no setting.