

UNIVERSAL SYSTEM FRAME USF-SERIES

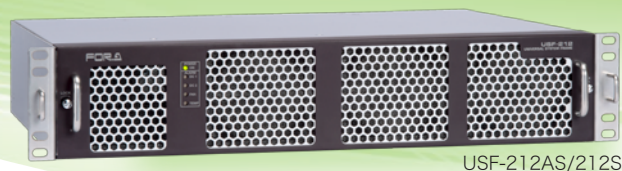

Universal modular frame designed for compact, economical system building. Build an optimal system for your environment from a full array of modules.

- Available frames
 - 1U size. Holds 5 modules.
 - USF-105AS (Supports 12G-SDI modules)
 - USF-105S
 - 2U size. Holds 12 modules.
 - USF-212AS (Supports 12G-SDI modules)
 - USF-212S
- Hot-swappable, front-accessible power unit and module bays
- New design combining SDI and Ethernet
- Two genlock inputs (Black burst (BB) or tri-level sync) (USF-212AS/212S)
- Built-in Gigabit Ethernet hub for GUI-based module configuration
- Frame operational monitoring (cooling fan and power) and module life-and-death monitoring using SNMP

Available modules

Below is the maximum number of modules mounted on each frame. For details, please contact FOR-A office.

Module \ Frame	USF-212AS	USF-105AS	USF-212S	USF-105S
USF-10IP	6	—	—	—
USF-10IPSDI6-FS	6	—	—	—
USF-10IPSDI12-FS	3	—	—	—
USF-106TICO-12G	6	2	—	—
USF-1043FS	12	5	12	5
USF-105FS-12G	12	4	—	—
USF-106UDC-12G	6	2	—	—
USF-1044UDC	6	2	6	2
USF-106DC-12G	6	2	—	—
USF-111DDA-12G	6	2	—	—
USF-105DDA-12G	12	5	—	—
USF-1053DDA	12	5	12	5
USF-1043VM	12	5	12	5
USF-1100VEA	6	2	6	2
USF-1040VEA	12	5	12	5
USF-105DADA	12	5	12	5
USF-108ADA	12	5	12	5
USF-204ADAC	12	5	12	5
USF-402AADC	12	5	12	5
USF-101MDX4-12G	6	2	—	—
USF-101MDX8-12G	6	2	—	—
USF-1013MUX	12	5	12	5
USF-1013DEMUX	12	5	12	5

Available modules

USF-10IP

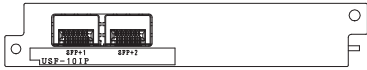

Dual 10 GbE (SFP+) ports

- Converts to other encapsulation modes
- Encapsulation modes: SMPTE 2022-5/6/7, SMPTE 2110, NMI

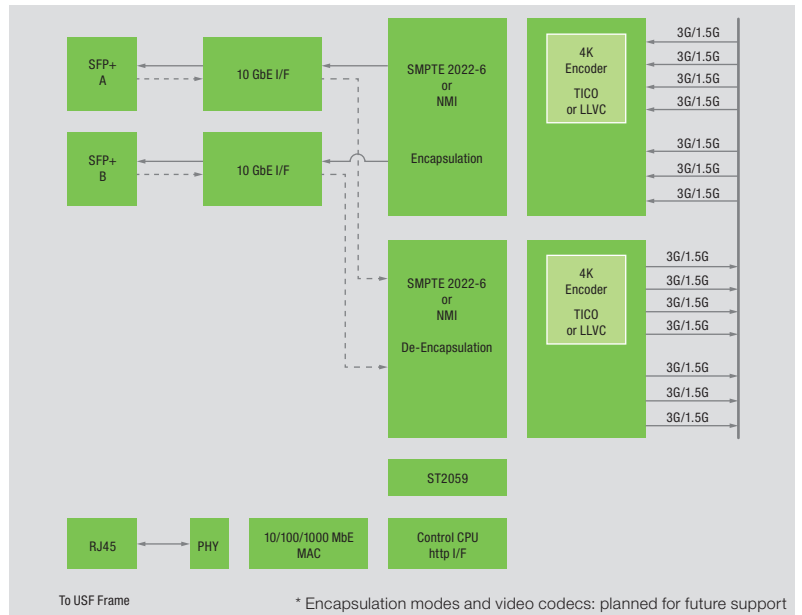

USF-10IPSDI6-FS

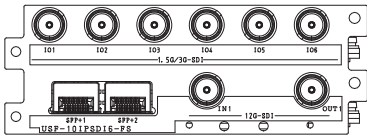

Frame/line synchronizer with dual 10 GbE (SFP+), 1-input/1-output 12G-SDI, and 6-input/6-output 3G/1.5G-SDI

- 2SI/SQD and Level A/B conversion
- SMPTE 2022-5/6/7, (uncompressed): Simultaneous conversion of up to 6 inputs or 6 outputs (6 streams)

USF-10IPSDI12-FS

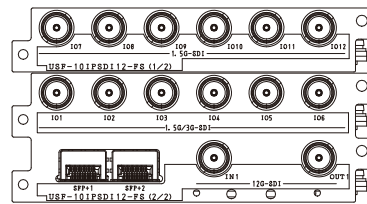

Frame/line synchronizer with dual 10 GbE (SFP+), 1-input/1-output 12G-SDI, and 12-input/12-output 3G/1.5G-SDI

- 2SI/SQD and Level A/B conversion
- SMPTE2022-5/6/7, (uncompressed): Simultaneous conversion of up to 6 inputs and 6 outputs (12 streams)

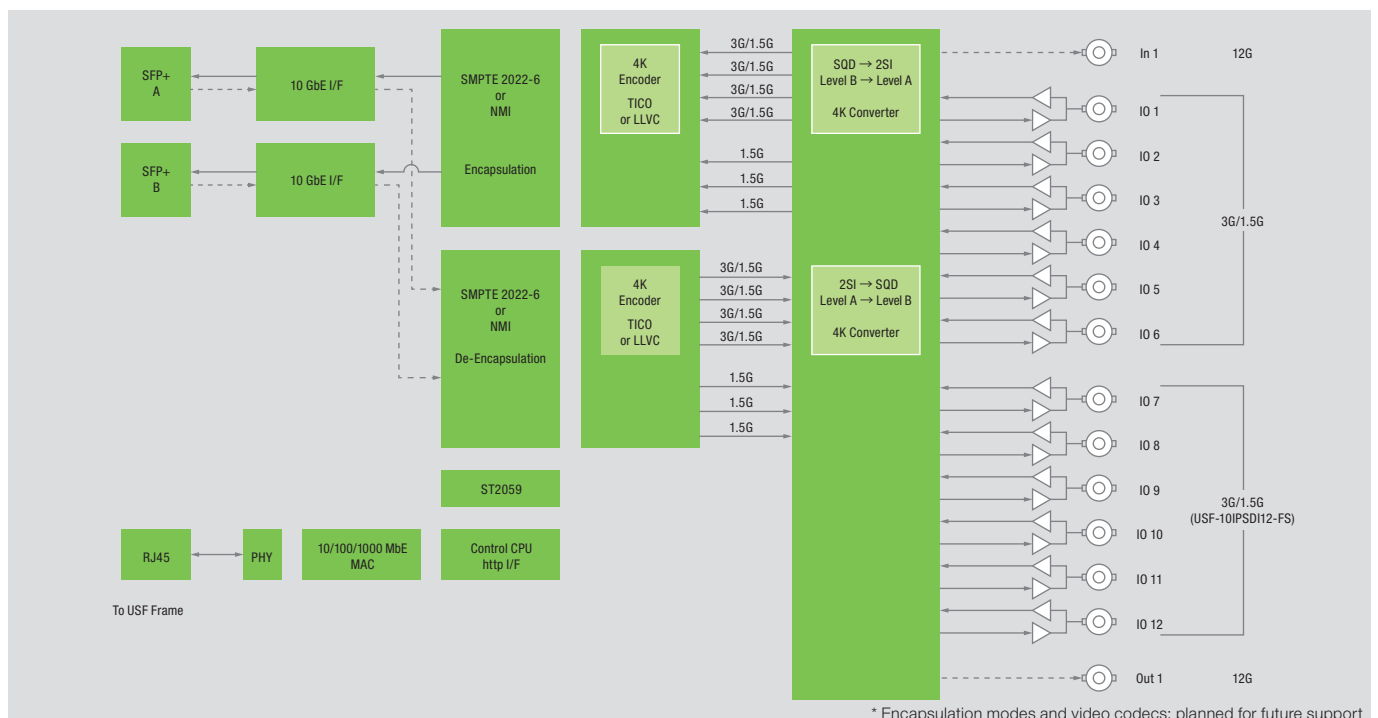

Available modules

USF-106TICO-12G

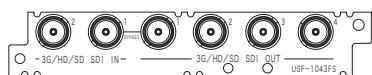

4K/TICO encoder/decoder

- TICO codec support enables video compression and expansion with high image quality and low latency. 4K video transfer over 3G-SDI
- One 12G-SDI input, 2 outputs
- 4K 2SI/SQD, Level A/B support
- Downconversion from 4K to HD (1080i/1080p)
- Upconversion available as an option
- HDR/WCG-compatible color processing
- Audio processing enables automatic/semi-automatic audio delay setting
- Frame synchronization

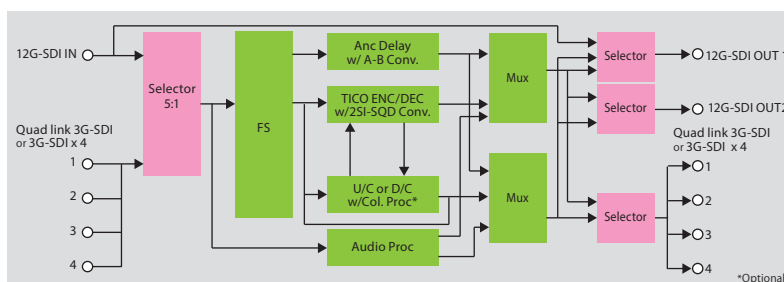

USF-105FS-12G

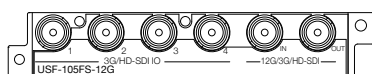

12G-SDI frame synchronizer

- Supports 3840 x 2160 single link 12G-SDI
- Supports 3840 x 2160 quad link (2SI, Level A) 3G-SDI (input and output are switched from a menu)
- 12G-SDI and quad link 3G-SDI (2SI, Level A) conversion
- FS mode: Adjusts phases and syncs asynchronous SDI signals to genlock signals
- Automatic muting for detected audio errors
- 16-channel audio sample rate converter (SRC)
- Audio delay adjustment for each channel (up to 1,000 ms), and audio channel remapping
- Audio downmixing for linear PCM
- H/V ancillary data pass-through (synchronous input only)
- Proc amp, video clip, video delay, and freeze
- 16-channel embedded audio support (asynchronous audio support for 3G/HD-SDI)
- SNMP monitoring

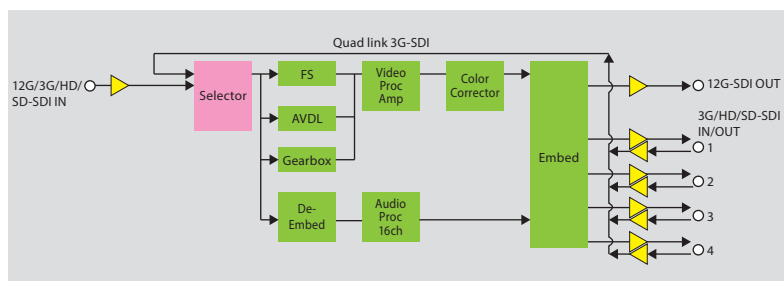

USF-1043FS

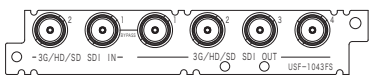

3G/HD/SD-SDI frame synchronizer

- Splits a 3G/HD/SD-SDI source selected from two inputs, for distributed output to four ports
- FS mode: Adjusts phases and syncs asynchronous SDI signals to genlock signals
- Automatic muting for detected audio errors
- 16-channel audio sample rate converter (SRC)
- Audio delay adjustment for each channel (up to 1,000 ms), and audio channel remapping
- Audio downmixing for linear PCM
- Seamless switching of audio and video inputs
- H/V ancillary data pass-through (synchronous input only)
- Proc amp, video clip, video delay, and freeze
- 16-channel embedded audio support (asynchronous audio support for 3G/HD-SDI)
- SNMP monitoring

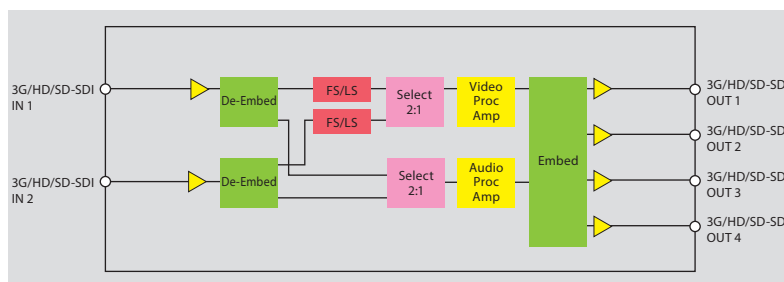

Available modules

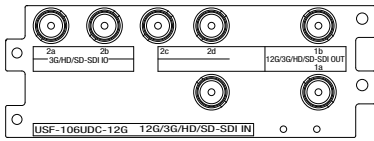
USF-106UDC-12G

12G-SDI 4K/HD up/down converter

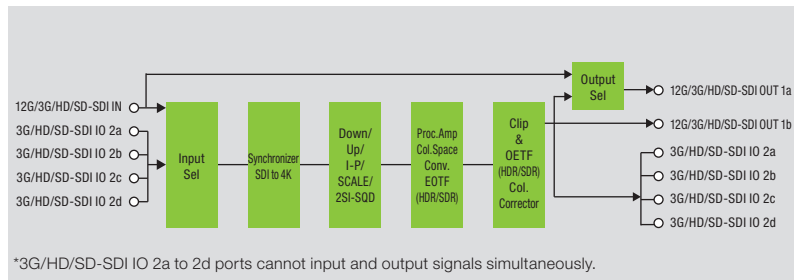
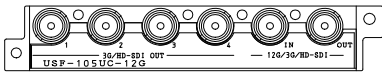
- Supports 3840x2160 single link 12G-SDI
- Supports 3840x2160 quad link (2SI/SQD) 3G-SDI(input and output are switched from a menu)
- 3G-SDI Level A/B conversion
- Dynamic range conversion
- Converts between ITU-R BT.2020/709
- 16-channel embedded audio support
- Sync modes: Frame, Line, AVDL
- Browser-based control via dedicated software GUI
- SNMP monitoring

USF-105UC-12G

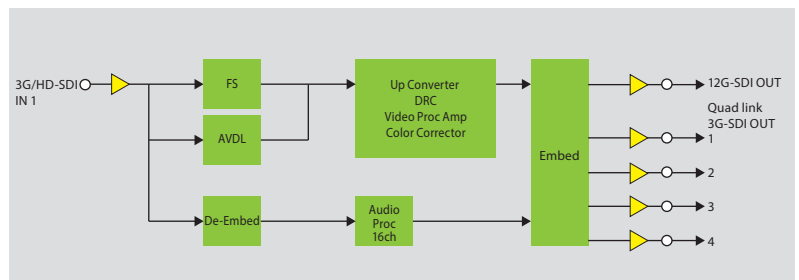
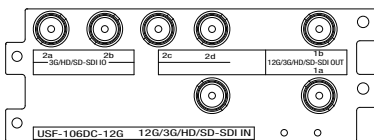
12G-SDI 4K up converter

- Supports 3G/HD-SDI input
- Supports 3840x2160 single link 12G-SDI and quad link (2SI/SQD) 3G-SDI outputs
- 3G-SDI Level A/B conversion
- Dynamic range conversion
- Converts between ITU-R BT.2020/709
- 16-channel embedded audio support
- Sync modes: Frame, Line, AVDL
- Browser-based control via dedicated software GUI
- SNMP monitoring

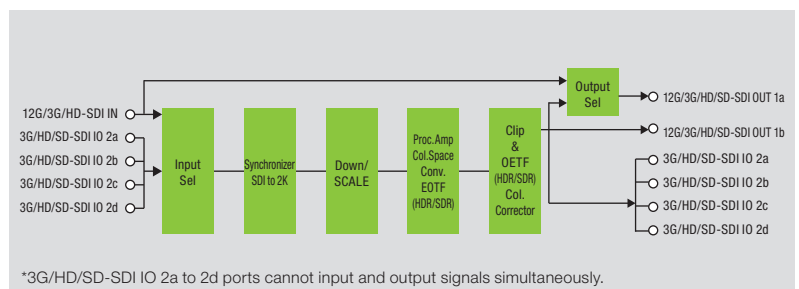

USF-106DC-12G

12G-SDI 4K to HD down converter

- Supports 3840x2160 single link 12G-SDI
- Supports 3840x2160 quad link (2SI/SQD) 3G-SDI (input and output are switched from a menu)
- Dynamic range conversion
- Converts between ITU-R BT.2020/709
- 16-channel embedded audio support
- Sync modes: Frame, Line, AVDL
- Browser-based control via dedicated software GUI
- SNMP monitoring

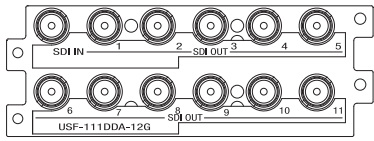

Available modules

USF-111DDA-12G



12G-SDI 11-output digital video distributor

- Supports SDI 12 Gbps, 3 Gbps, 1.5 Gbps, or 270 Mbps signals
- DVB-ASI (270 Mbps) also supported
- SNMP monitoring

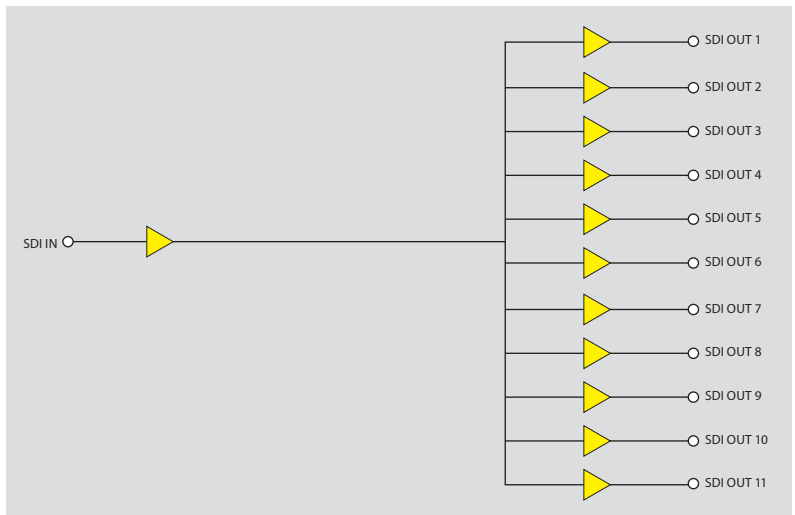

USF-105DDA-12G

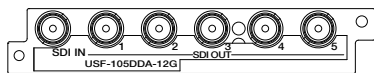

12G-SDI 5-output digital video distributor

- Supports SDI 12 Gbps, 3 Gbps, 1.5 Gbps, or 270 Mbps signals
- DVB-ASI (270 Mbps) also supported
- SNMP monitoring

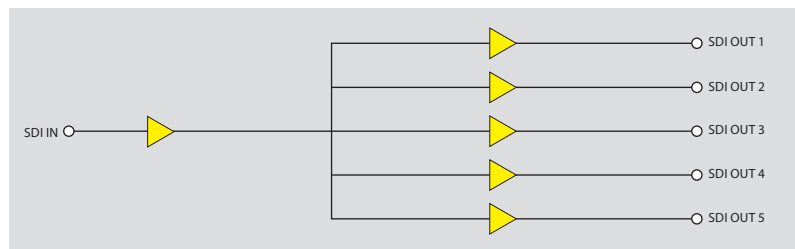

USF-1053DDA



5-output 3G/1.5G/270 Mbps digital video distributor

- 3G/HD/SD-SDI equalization and reclocking
- Supports SDI 3.0 Gbps, 1.5 Gbps, or 270 Mbps signals
- DVB-ASI (270 Mbps) also supported
- SNMP monitoring

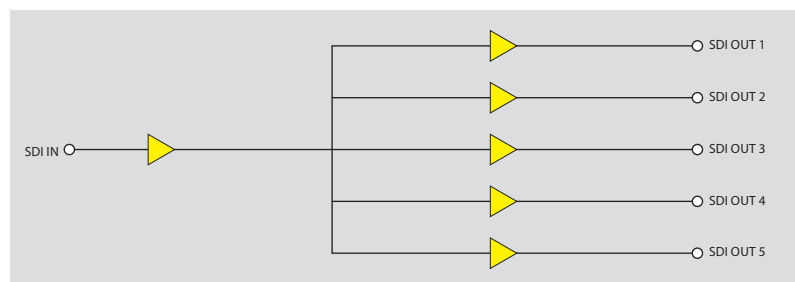

USF-1043VM

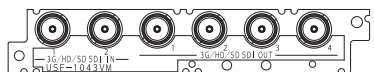

3G/HD/SD-SDI digital video distributor with signal monitor

- Supports SDI 3 Gbps, 1.5 Gbps, or 270 Mbps signals
- Can be configured for 1-input/4-output or 2-input/2-output systems
- Switches seamlessly to the other line when errors of input signals are detected
- SNMP monitoring

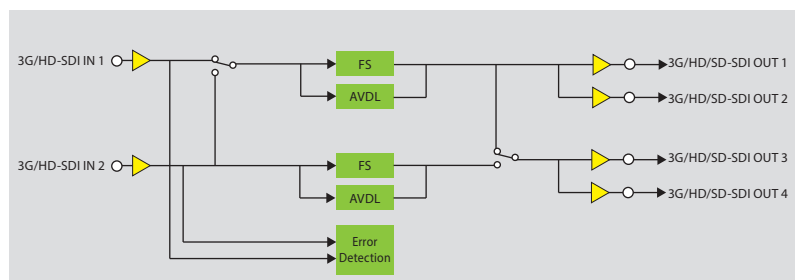

Available modules

USF-1100VEA

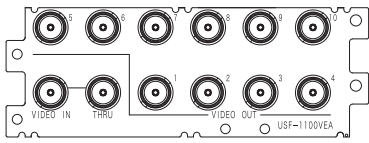

10-output analog video distributor

- Cable equalization corrects frequency characteristics in analog video distribution
- Ideal for BB or tri-level sync signal distribution
- Pass-through input supported
- Browser-based control and SNMP monitoring (optional)

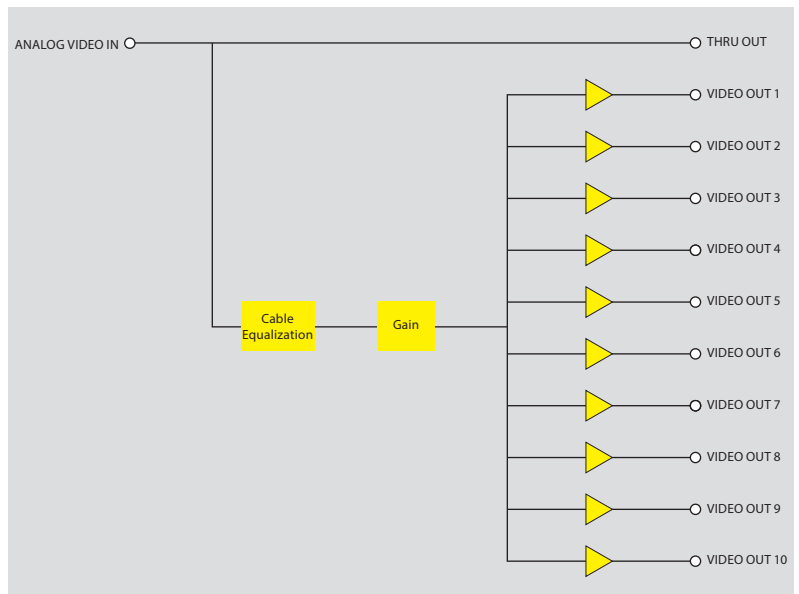

USF-1040VEA



4-output analog video distributor

- Cable equalization corrects frequency characteristics in analog video distribution
- Ideal for BB or tri-level sync signal distribution
- Pass-through input supported
- Browser-based control and SNMP monitoring (optional)

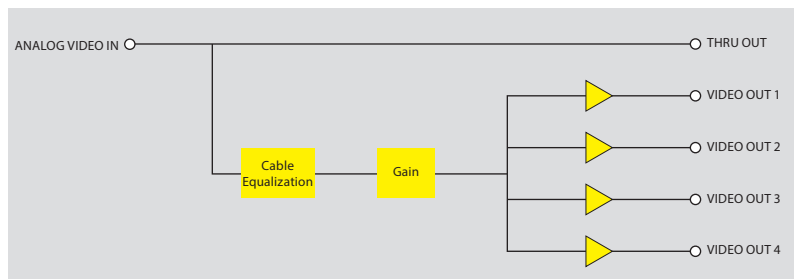

USF-105DADA



5-output unbalanced digital audio distributor

- Expandable to 20 outputs, using four modules
- LTC and word clock distribution also supported
- SNMP monitoring

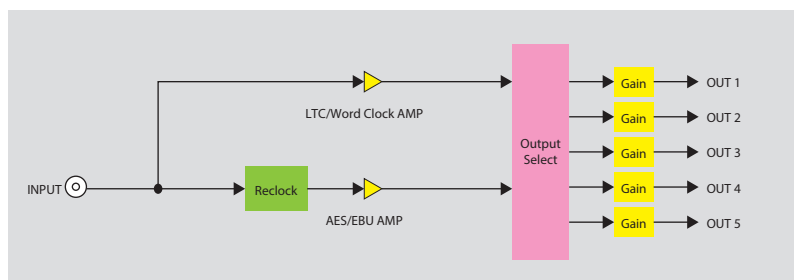

Available modules

USF-108ADA

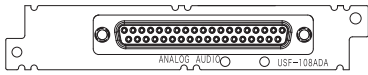

8-output analog audio distributor

- Can be configured for 1-input/8-output or two 1-input/4-output systems
- Browser-based control and SNMP monitoring (optional)

When distributing 1 input to 8 outputs

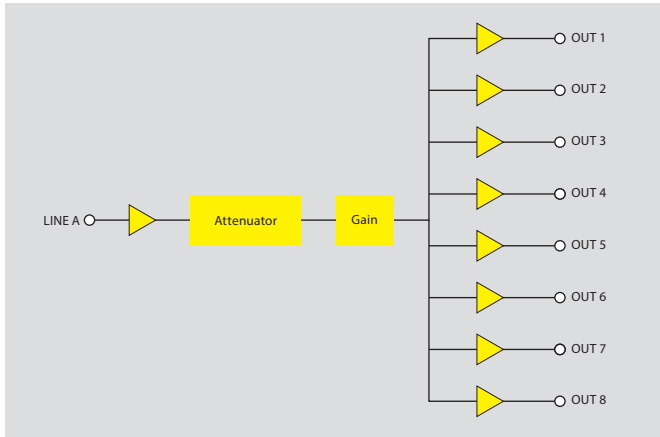

When distributing 1 input to 4 outputs (2 inputs to 8 outputs in total)

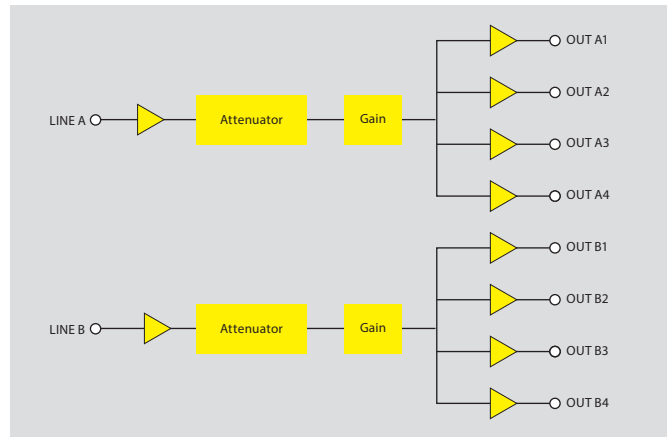

USF-204ADAC

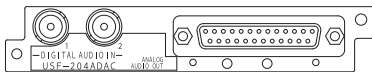

Digital-to-analog audio converter with AES/EBU two-channel input*/output

- Converts two channels of digital audio to four channels of analog audio
- Adjustable digital audio input level (-20/-18 dBFS)
- Adjustable audio output level (-10/0/4/8 dBu)
- Adjustable audio silence period (1 to 10 sec)
- Supports output synced with reference signals from the USF
- SNMP monitoring

*Asynchronous input not supported. AES/EBU signals are required to be synced with reference signals from the USF frame.

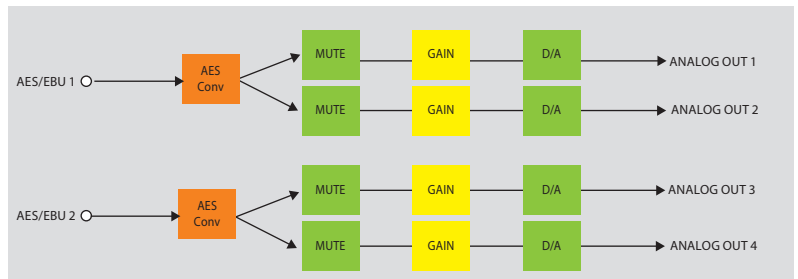

USF-402AADC

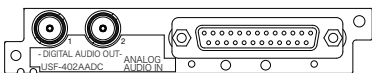

Analog-to-digital audio converter

- Converts four channels of analog audio to two channels of digital audio
- Adjustable input impedance (600Ω/high)
- Adjustable input gain (±6 dB with front dial, ±20 dB via browser)
- Adjustable analog audio input level (-10/0/4/8 dBu)
- Adjustable digital audio reference level (-18/-20 dBFS)
- Adjustable audio silence period (1 to 10 sec)
- Supports output synced with reference signals from the USF
- SNMP monitoring

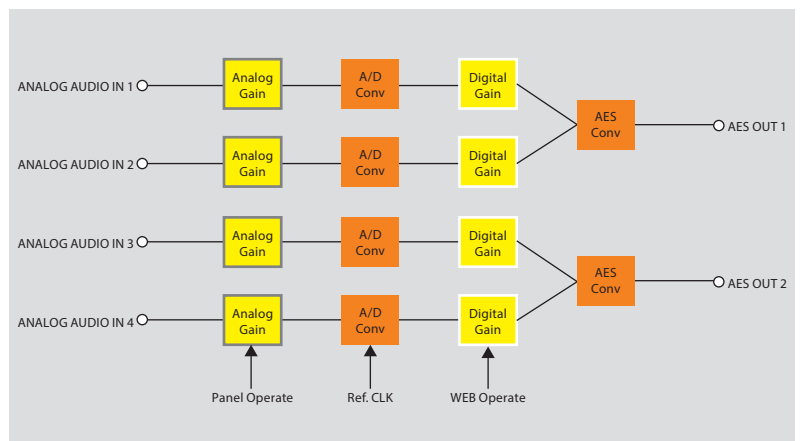

Available modules

USF-101MDX4-12G

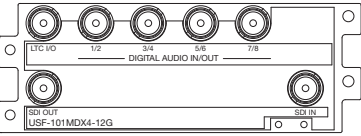

12G-SDI 4K audio multiplexer/demultiplexer with 8 channels of AES I/O

- Supports transfer rates from 270 Mbps to 12 Gbps
- Sync modes: Frame, Line, AVDL
- Sample rate converter (SRC) for MUX/DEMUX of asynchronous AES/EBU signals (switched from a menu)
- MUX: Mapping 8 channels (4 pairs) of AES/EBU signals in 16 channels (at 4K) and embedding onto SDI signals
- DEMUX: De-multiplexes 8 selected channels from 16 channels from SDI signals as AES/EBU audio output
- LTC port is used for input and output
- SNMP monitoring

MUX

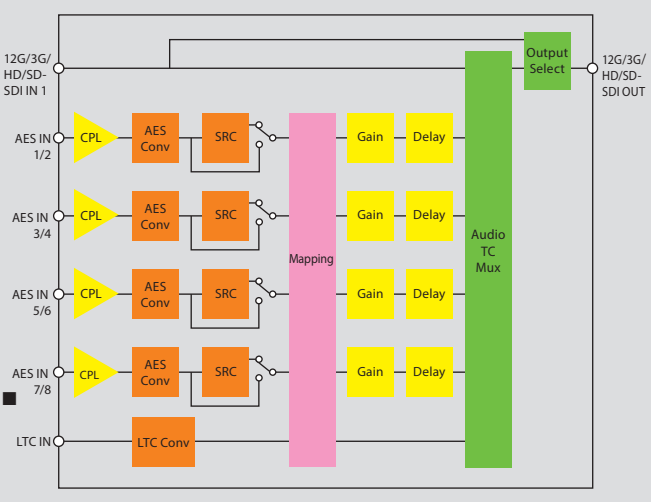

DEMUX

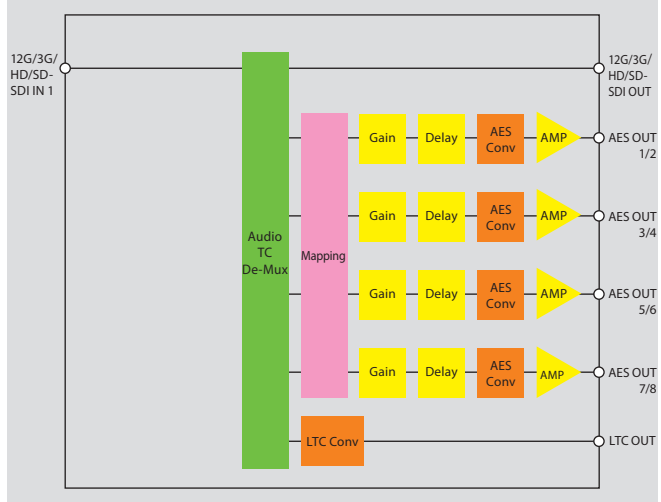

USF-101MDX8-12G

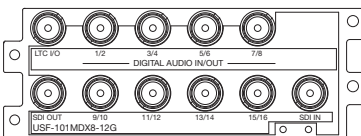

12G-SDI 4K audio multiplexer/demultiplexer with 16 channels of AES I/O

- Supports transfer rates from 270 Mbps to 12 Gbps
- Sync modes: Frame, Line, AVDL
- Sample rate converter (SRC) for MUX/DEMUX of asynchronous AES/EBU signals (switched from a menu)
- MUX: Mapping 16 channels (8 pairs) of AES/EBU signals in 16 channels (at 4K) and embedding onto SDI signals
- DEMUX: De-multiplexes 8 selected channels from 16 channels from SDI signals as AES/EBU audio output
- LTC port is used for input and output
- SNMP monitoring

MUX

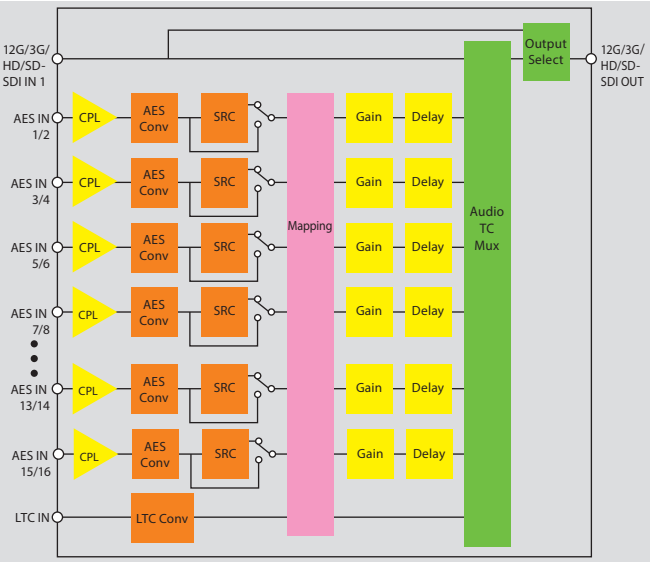

DEMUX

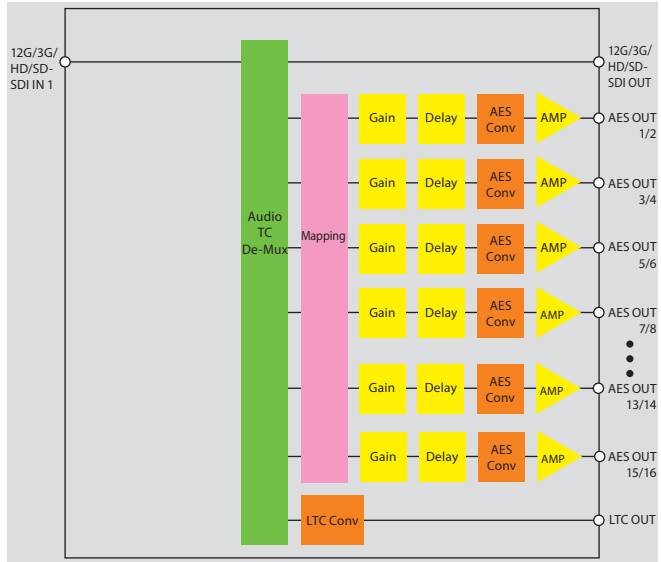

Available modules

USF-1013MUX



3G/HD/SD-SDI digital audio multiplexer

- Multiplexes 4 pairs (8 channels) of AES/EBU signals onto SDI signals
- 1 input and 1 output (3G/HD/SD-SDI)
- Gain adjustment for audio input/output
- Timecode (LTC) input (or AES IN 7/8 available)
- Sample rate converter for AES/EBU input
- SNMP monitoring

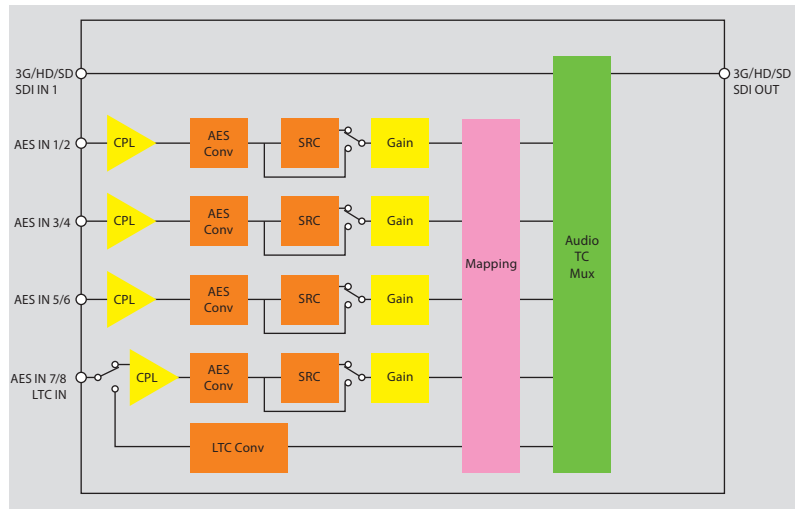

USF-1013DEMUX

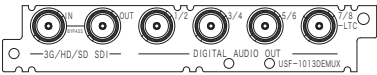

3G/HD/SD-SDI digital audio demultiplexer

- De-multiplexes audio from SDI signals into AES/EBU audio output
- 1 input and 1 output (3G/HD/SD-SDI)
- Gain adjustment for audio input/output
- Timecode (LTC) input (or AES IN 7/8 available)
- SNMP monitoring

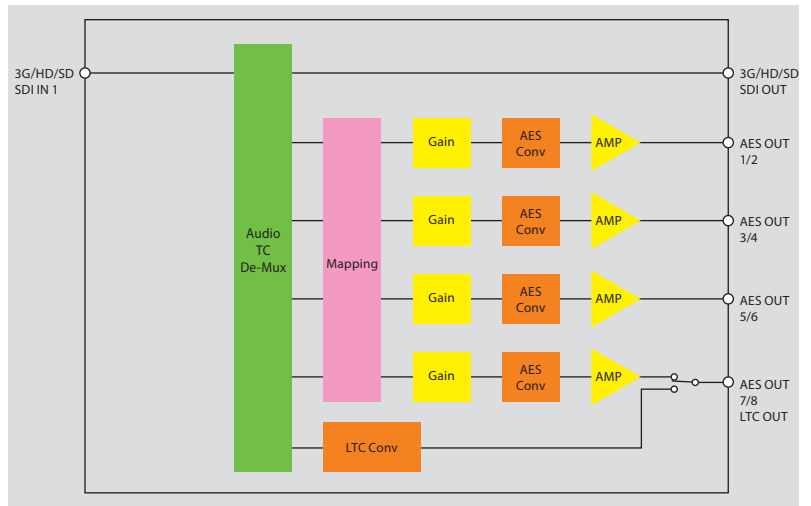

Front view (when the front panel is removed)

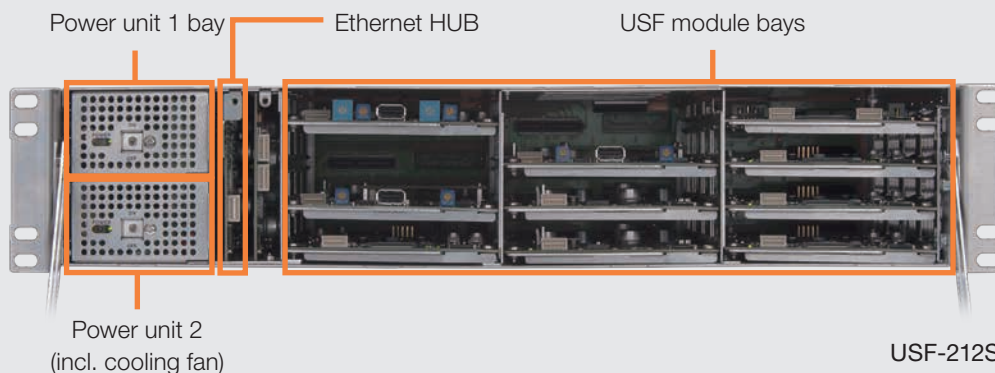

External view

Unit: mm

USF-212AS

Front

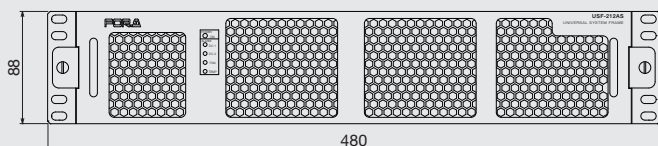

Side

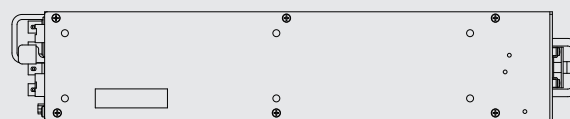

USF-105AS

Front

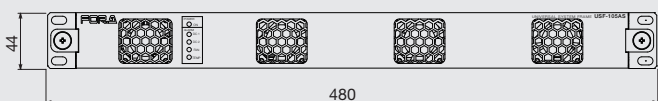

Side



Rear view

USF-212AS

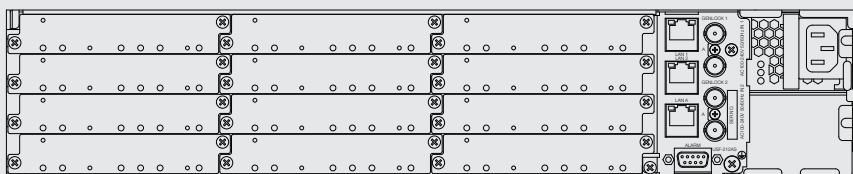

USF-105AS

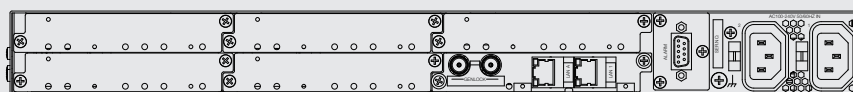

INNOVATIONS IN VIDEO and AUDIO TECHNOLOGY Head Office: 3-8-1 Ebisu, Shibuya-ku, Tokyo 150-0013, Japan

FOR-A Corporation of America Corporate Office/ Service Center:

Tel: +1 714-894-3311

11155 Knott Ave., Suite G, H & I, Cypress, CA 90630, U.S.A.

FOR-A Corporation of America Northeast Office:

Tel: +1 973-220-847

1360 Clifton Ave., Clifton, NJ 07012, U.S.A.

FOR-A Corporation of America Support Center:

Tel: +1 352-371-1505

2400 N.E. Waldo Road, Gainesville, FL 32609, U.S.A.

FOR-A Latin America and the Caribbean Miami Office:

Tel: +1 657-600-5759

FOR-A Latin America and the Caribbean Sao Paulo Office:

Tel: +55 11-99913-3751

FOR-A Europe S.r.l.:

Tel: +39 039-916-4811

Via Volturmo, 37, 20861 Brughiero MB, Italy

FOR-A UK Limited:

Tel: +44 (0)20-3044-2935

Trident Court, 1 Oakcroft Road, Chessington, KT9 1BD, UK

FOR-A Italia S.r.l.:

Via Volturmo, 37, 20861, Brughiero MB, Italy

FOR-A Corporation of Korea:

Tel: +39 039-881-086/103

1007, 57-5, Yangsan-ro, Yeongdeungpo-gu, Seoul 150-103, Korea

Tel: +82 (0)2-2637-0761

FOR-A China Limited:

1618 Huateng Building, No. 302, 3 District, Jinsong, Chaoyang, Beijing 100021, China

Tel: +86 (0)10-8721-6023

FOR-A Middle East-Africa Office:

Dubai Media City, Aurora Tower, Office 1407, P.O. Box 502688, Dubai, UAE

Tel: +971 (0)4-551-5830

AGIV (India) Private Limited:

2nd Floor, Valecha Chambers, Link Road, Andheri (W), Mumbai 400053, India

Tel: +91 22-2673-3623

FOR-A South East Asia Office:

Studio 09, Rm. A1, 3/F., Phase 1, Hang Fung Ind. Bldg., 2G Hok Yuen St., Hung Hom, Hong Kong

Tel: +852 2110-1352